

Thingsee

PRESENCE

Quick Guide



- 1.** Identify the sensor by reading the QR code on the front of the device.

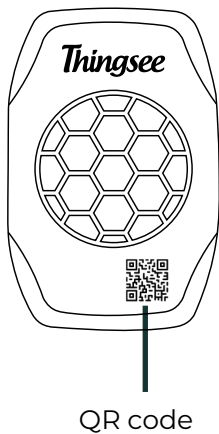

- 2.** Carefully pull out the battery security tab.

Security tab

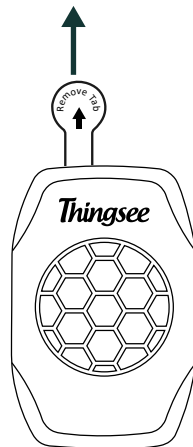

- 3.** Clean the installation surface with IPA solvent.

Surface

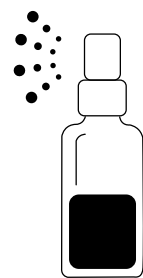

- 4.** Remove the tape's paper cover.

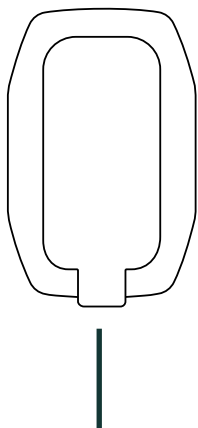

- 5.** Install the sensor to designated location by pushing firmly against the surface for a minimum of 5 seconds. Wipe the sensor with a dry, clean cloth.

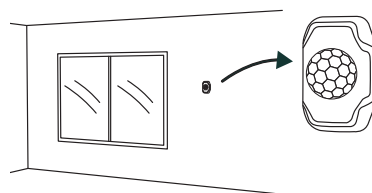

- 6.** Different domes can be used to easily adjust the detection beam for different use cases.

Visitor counter dome

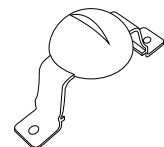

Occupancy dome

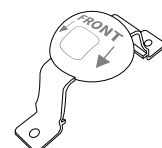

Continue to read the detailed installation instructions.

Watch installation video here



Thingsee PRESENCE

User and Installation Guide

v.24.04

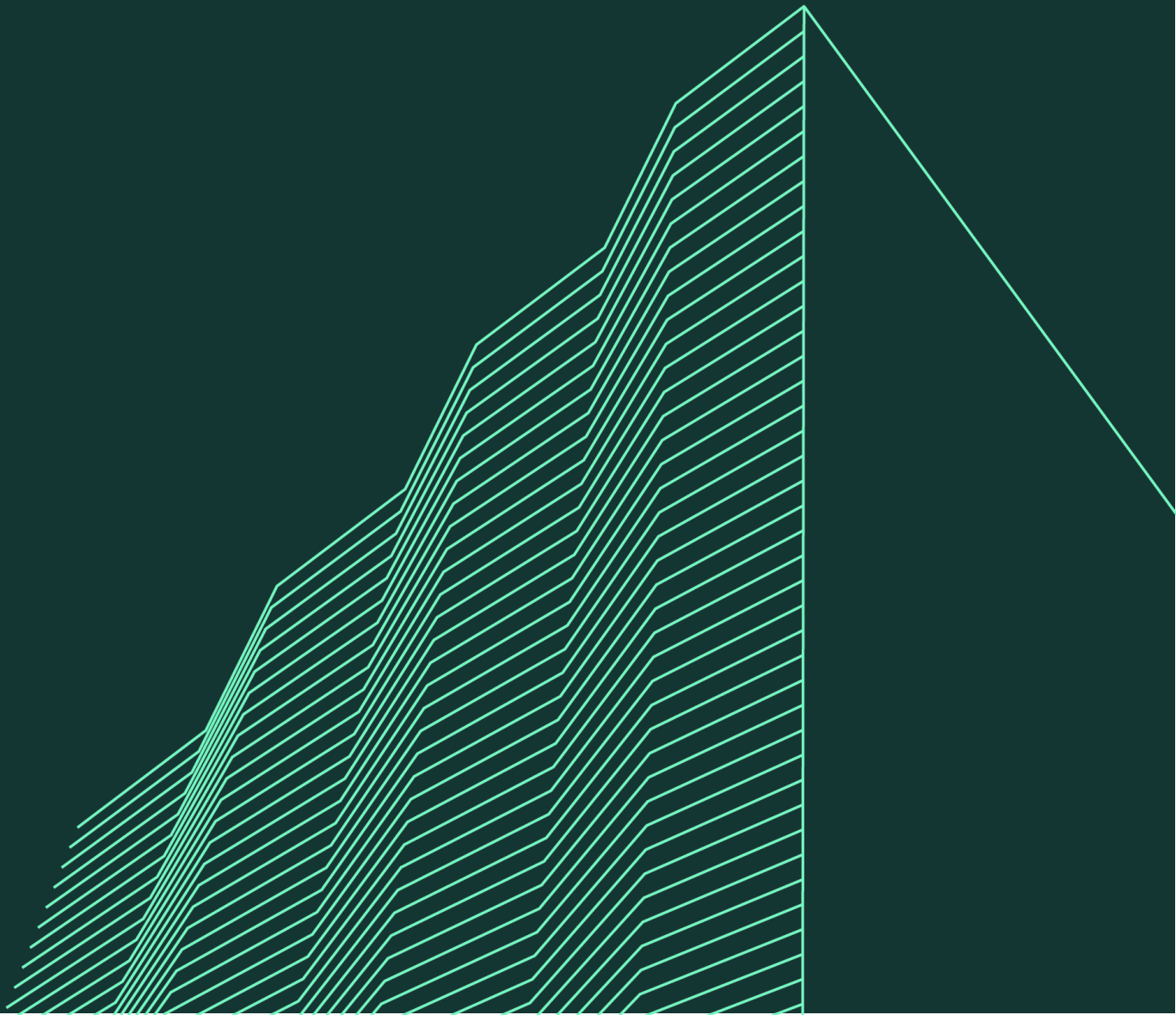

Welcome to using Haltian Thingsee

We at Haltian want to make IoT simple, so we have created a solution that is easy to use, scalable, and secure. I hope it will help you achieve your business goals!

Pasi Leipälä
CEO, Haltian Oy

Thingsee ENVIRONMENT



Wireless sensor for measuring people presence through your facility.

Thingsee PRESENCE gives you information on people movement in your spaces. You can use the sensor for facility management, workspace occupancy and visitor count. The sensor uses a passive infrared sensor to detect movement in a specific area.

Sales package content

- Thingsee PRESENCE sensor
- 1 x Opening Key
- 2 x AAA batteries (pre-installed, replaceable)

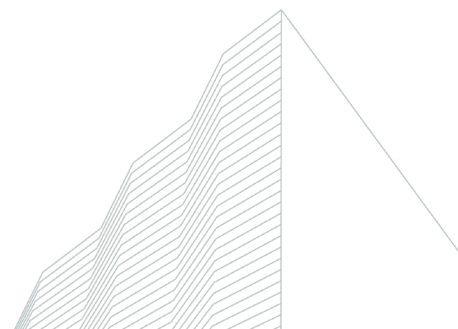

Using Thingsee PRESENSE sensor

Sensor detects the movement based on body heat detection.

Using sensor for visitor counting

Sensor can be used for visitor counting in places like door ways and corridors. Thingsee Visitor Counter Dome is available for this purpose.

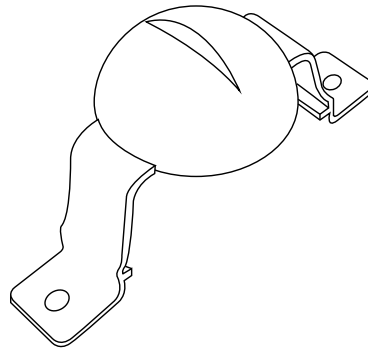

Using workspace occupancy detection

Thingsee PRESENSE can be installed under a table to detect the usage of a working space. Sensor sensitivity should be decreased to avoid unwanted detections outside the working space. This is possible with Thingsee Occupancy Dome.

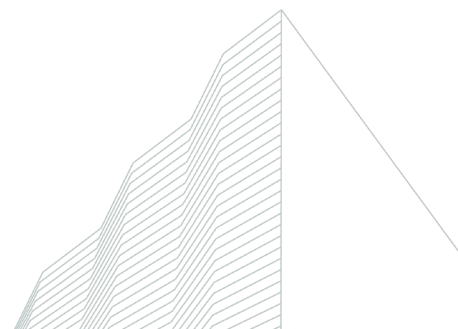
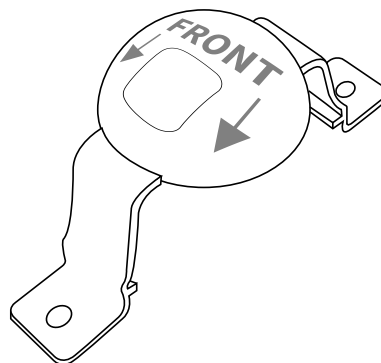

General installation instructions

Sensor is for indoor use only. The sensor is more sensitive to movement across the sensor detecting area than towards the sensor.

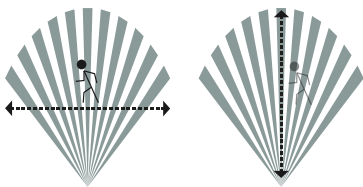

The sensor can only measure movement inside the detecting area. It is not a volumetric sensor.

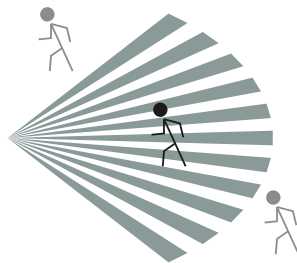

When attaching to a wall, place the sensor around 2/3rds of the wall height to avoid unnecessary detection of pets or other domestic animals. Sensor sensitivity can be also reduced in such cases.

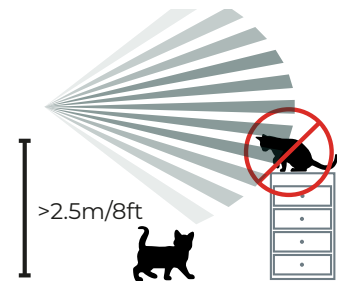

In a large area, use multiple sensors to cover all required movement.

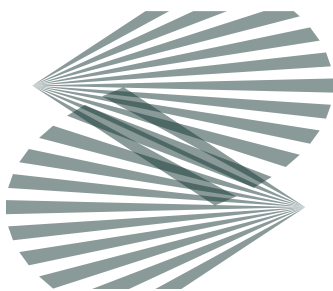

Sensors can also be placed either to a wall or to a ceiling.

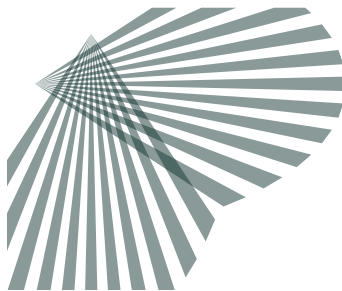

If sensors are placed on a ceiling in a low height space, sensors should be placed close enough to each other to cover the entire detecting area.

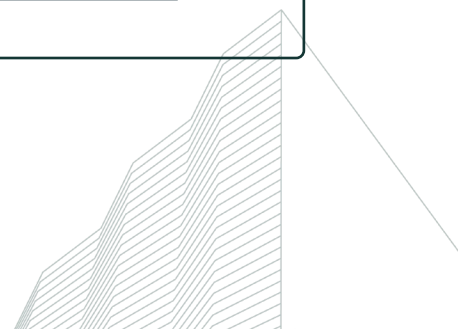
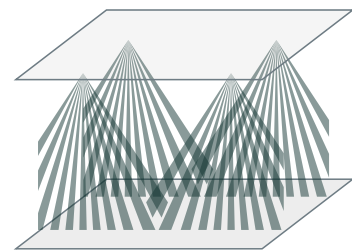

Thingsee PRESENCE detection capability changes related to the height of the space. Following chart describes different distances.

Adjusted sensitivity levels shown as white lines inside the maximum area are for illustration purposes only. Detection area changes related to sensor sensitivity level. Thingsee PRESENCE

detects people movement in its detection area with maximum of 34 movements per minute despite the movement's direction or distance from the sensor.

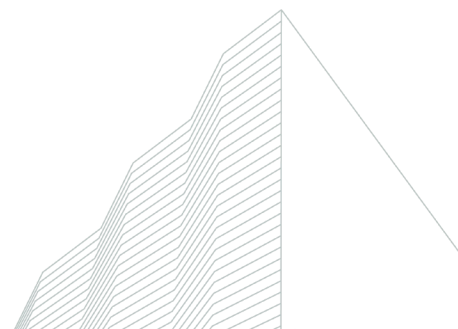
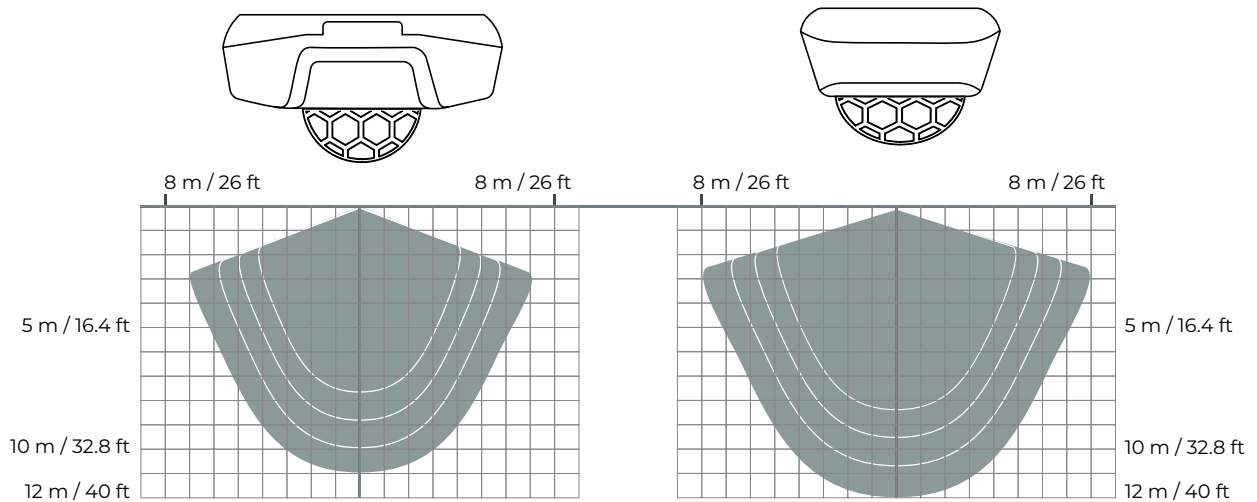

Things to avoid in installation

Avoid installing Thingsee products near the following:

1. Nearby heating or cooling devices and/or vents.

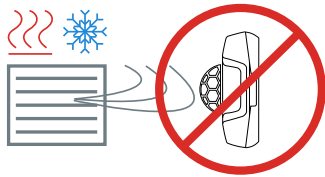

2. Direct sun light.

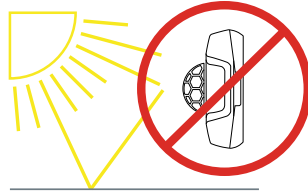

3. Nearby halogen lamps, fluorescent lamps or similar lamps with hot surface.

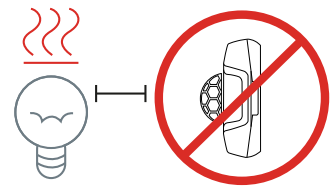

4. Places where a door or a similar object can block the required detection area.

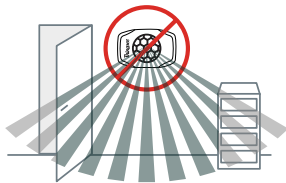

5. Attachment to surfaces which can vibrate as it may cause false functionality.

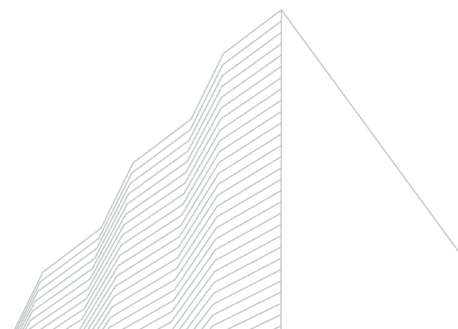

Installation

Before installing the sensors, make sure the Thingsee gateway device is installed and connected to a mobile network (LED blinking green).

To identify the sensor, read the QR code on the front of the device with a QR code reader or Thingsee Toolbox application on your mobile device.

Identifying the device is not necessary, but it will help you keep track of your IoT installation and help Haltian support to solve possible issues.

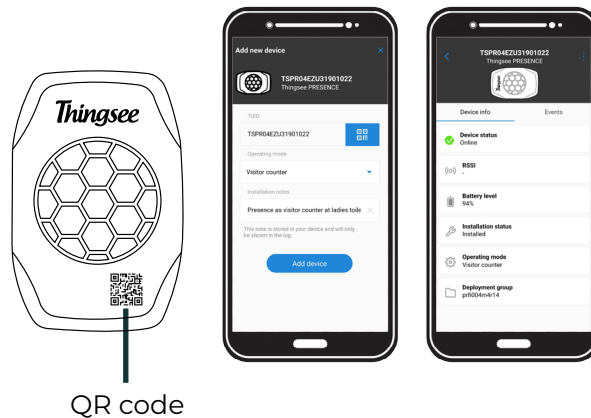

Carefully pull out the battery security tab.

LED indicator (red) will flash once. If the LED doesn't flash within 2 minutes, tap the sensor against your palm. If you do not see the LED blink or see the events from the sensor within 5 minutes, re-install the batteries.

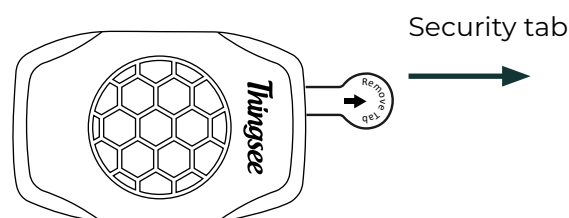

Clean the surface you will attach the sensor to with IPA -solvent (isopropyl alcohol).

Remove the tape's paper cover from the backside of the sensor.

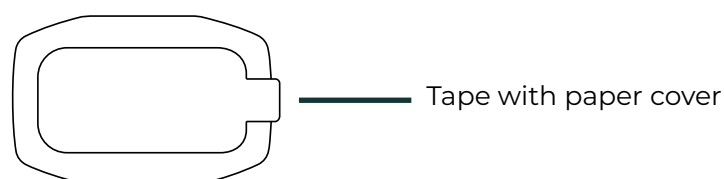

Attach the sensor to its place by pushing it firmly against the surface for a minimum of 5 seconds. Wipe the sensor with a dry, clean cloth.

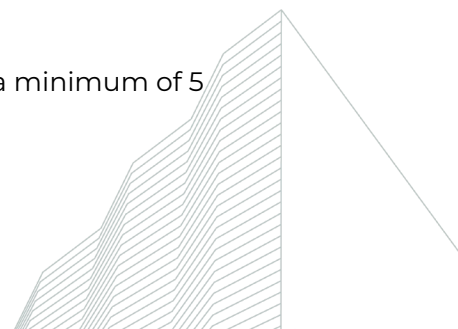

Visitor counting

Installing the sensor to a ceiling

Place the sensor in the middle of the door opening, 5 to 10 cm from the wall. Make sure that there are no objects between the sensor and the area to be detected.

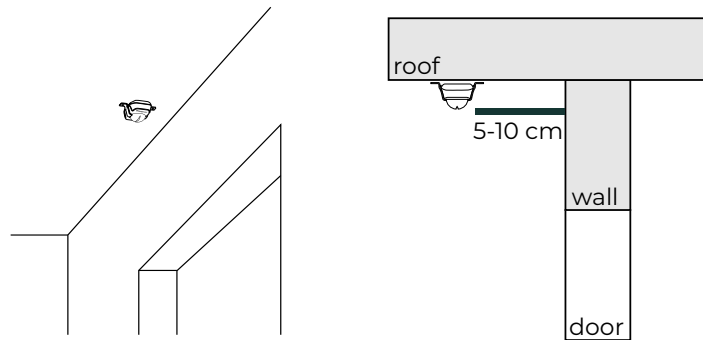

Installing the sensor to a door opening

Install Thingsee PRESENCE sensor to the top middle of the door opening. Make sure that there are no objects between the sensor and the area to be detected.

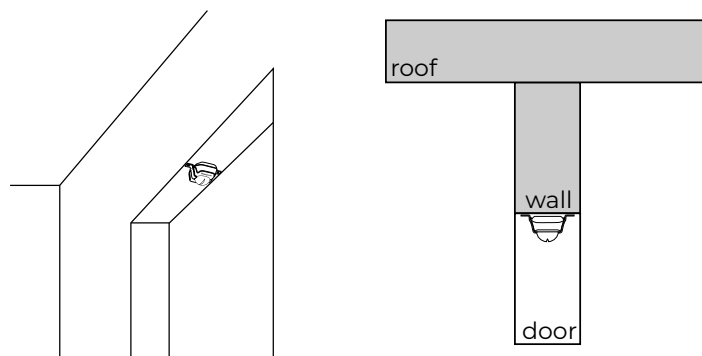

Movement direction

The sensor should be installed related to the visitor movement direction as shown in the image.

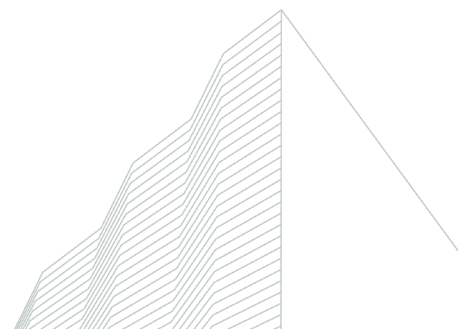
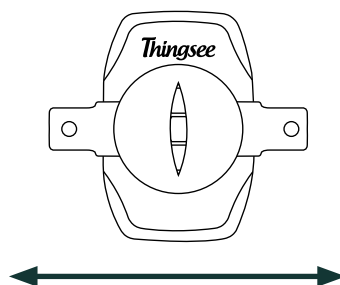

Using Visitor Counter Dome

The detection beam can easily be adjusted with a separate, easy to install, Visitor Counter Dome. It makes the detection beam more accurate.

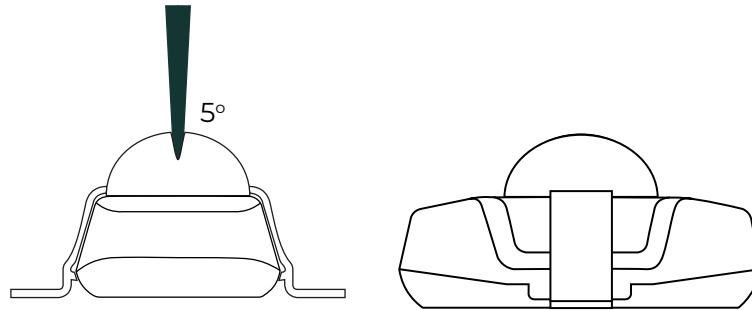

Note that with the Dome, the detection area is narrowed related to the long side of the Thingsee PRESENCE sensor.

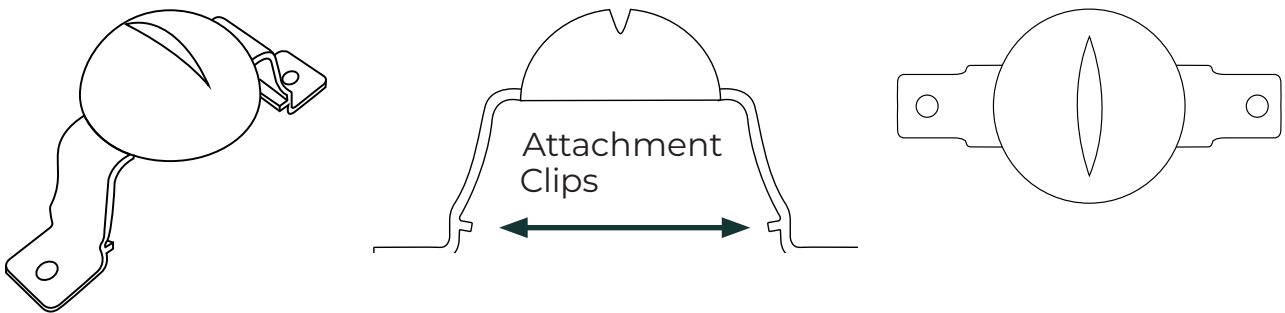

Detection area shape

Detection area shape and dimension related to the most common installation distances.

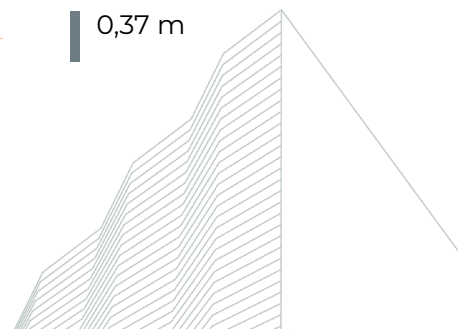
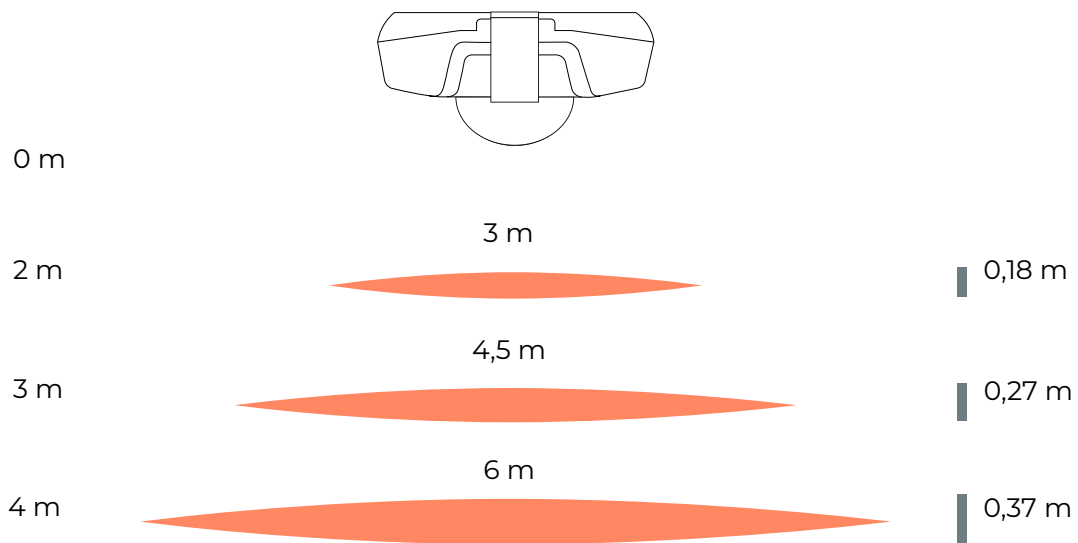

Workplace occupancy detection

Thingsee PRESENCE can be installed under a table to detect the usage of a working space. Sensor sensitivity should be decreased to avoid unwanted detections outside the working space.

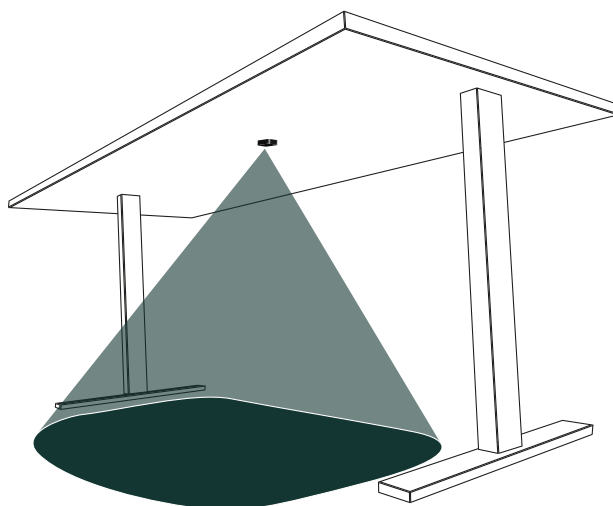

Installing the sensor under a table

Install Thingsee PRESENCE under the table as middle as possible. If there are any objects, such as table legs, under the table, place the sensor on the user side of the object. Make sure there is a 50 mm gap between Thingsee PRESENCE and the object so that it can be easily maintained.

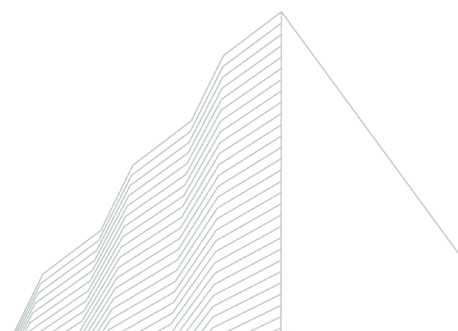
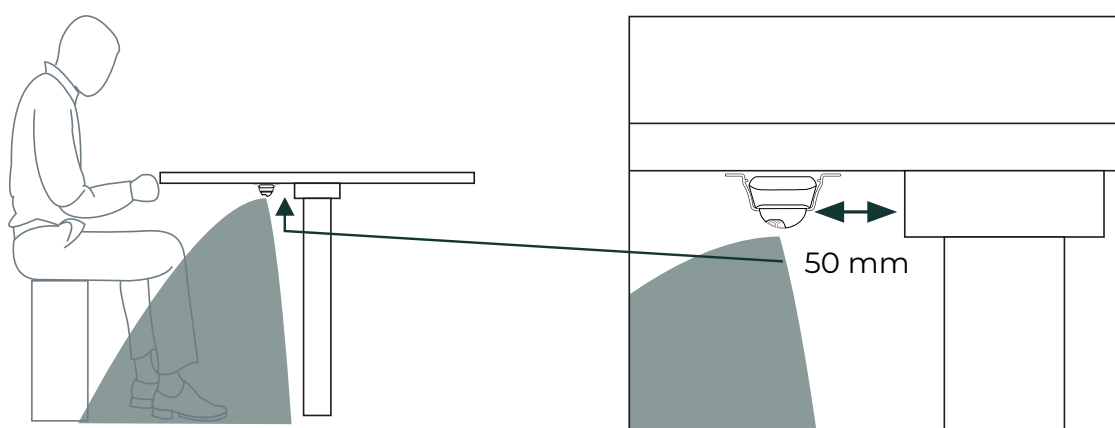

Using Workplace Occupancy Dome

The detection beam can easily be adjusted with a separate, easy to install, Workplace Occupancy Dome. The detection beam is more accurate when the hole on top of the sensor is facing the front.

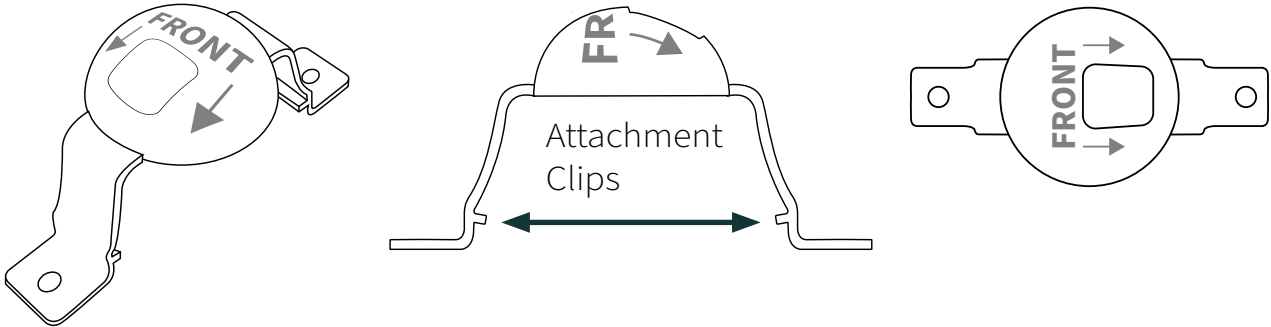

Good to know about installing the Dome

The Dome can be attached with screws to ensure the installation.

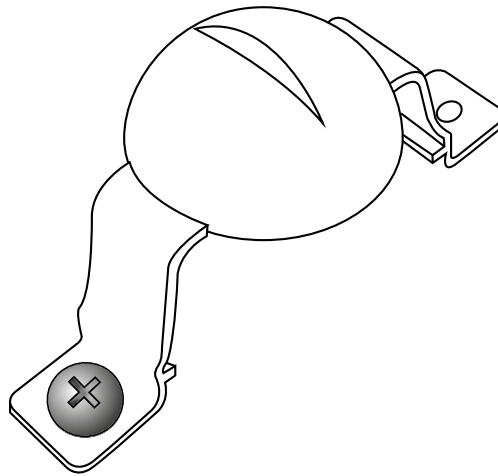

Use the correct screw type!

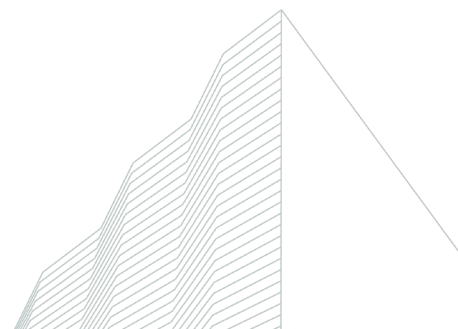
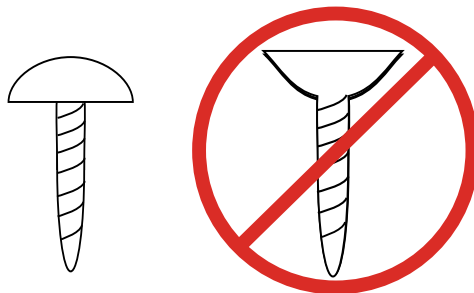

When using the attachment clips only, the screw attachment parts can be cut off.
Do not damage attachment clips while cutting!

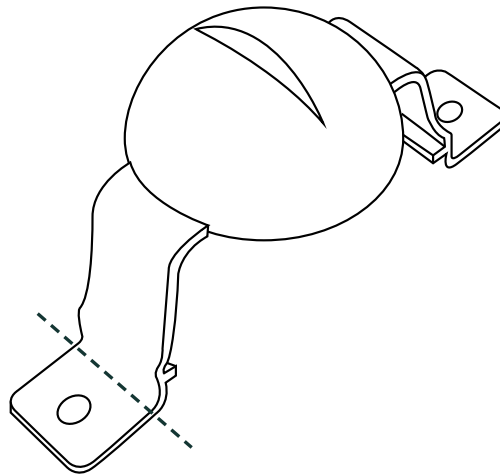

Changing the batteries

If you change the batteries, Haltian recommends using Varta Industrial Pro 1.5 V AAA LR06 alkaline batteries.

Open the sensor to change the batteries or reboot the device by replacing the batteries.

Place the opening
key to the hole
on the side of the
sensor

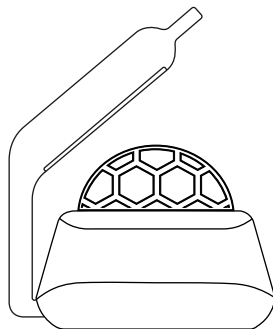

Bend the key to the
direction shown

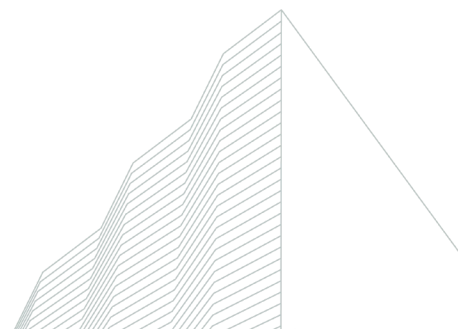
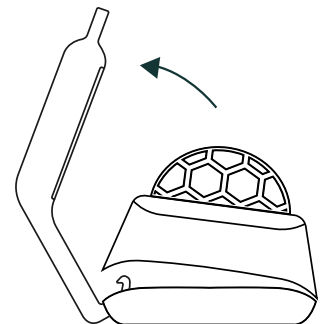

Default functionality and configuration

In visitor counter mode reports an indicative count of detected movements every 1 minute when movement is observed and every 1 hour if there is no movement and in occupancy mode reports every time the status changes and if there is no changes in status sensor reports every one hour.

Max count per minute is 34 events

The device LED blinks (red) once when starting up

Radio connectivity: Wirepas Mesh

The following parameters are configurable remotely over Thingsee Operations Cloud:

- Reporting interval
- Passive reporting interval
- Sensor sensitivity level

Movement indication LED ON/OFF

Device info

Operating temperature: -20 °C ... +50 °C

Operating humidity: 0 % ... 100 % RH non-condensing

Storage temperature: 0 °C ... +25 °C

Storage humidity: 45 % ... 60 % RH non-condensing

IP rating grade: IP40

Certifications: CE, FCC, ISED, RoHS, RCM, MIC, UKCA, WPC ETA-SD, IMDA, KC and NOM + NYCE, IFT compliant

Battery type: 2 x AAA, replaceable

Expected battery life:

- Up to 4 years, with standard firmware

Radio sensitivity: -95 dBm (BTLE)

LED light for confirmation purposes

Adjustable sensor sensitivity

More device info can be found at support.haltian.com

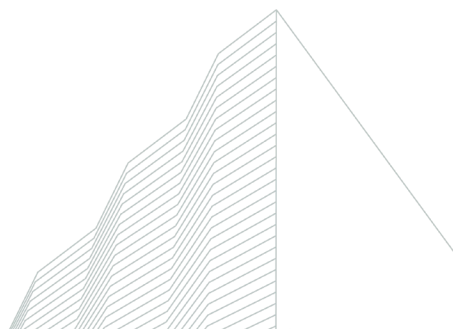

Device dimensions

Weight:
37 g (including batteries)

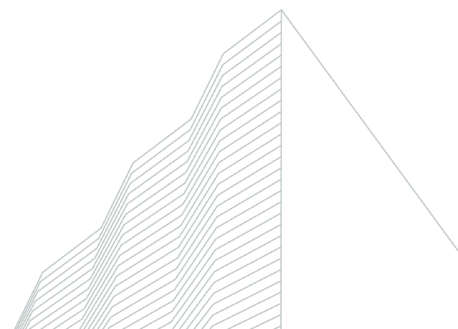
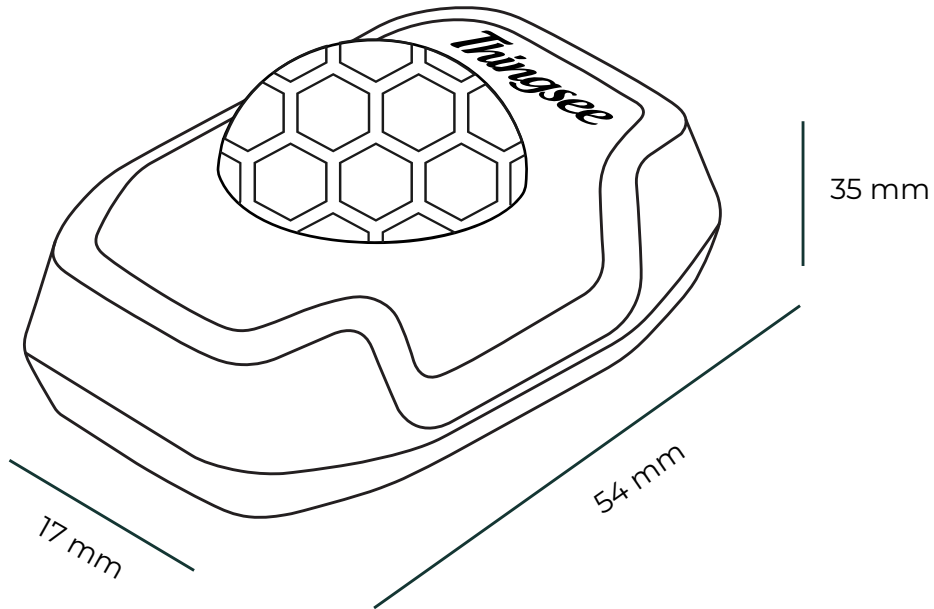

CERTIFICATION INFORMATION
EU DECLARATION OF CONFORMITY

Hereby, Haltian Oy declares that the radio equipment Thingsee PRESENCE is in compliance with Directive 2014/53/EU. The full text of the EU declaration of conformity is available at the following internet address: support.haltian.com

Haltian Oy vakuuttaa, että radiolaitetyyppi Thingsee PRESENCE on direktiivin 2014/53/EU mukainen. EU-vaatimusten mukaisuusvakuutuksen täysimittainen teksti on saatavilla seuraavassa internetosoitteessa: support.haltian.com

Hereby, Haltian Oy declares that the radio equipment type TPR is in compliance with the UK relevant statutory requirements (Radio Equipment Regulations 2017 (SI 2017 No. 1206)). The full text of the declaration of conformity is available at the following internet address: support.haltian.com

Thingsee PRESENCE operates at Bluetooth® 2.4 GHz frequency band. Maximum radio-frequency power transmitted is +4.0 dBm.

Manufacturer name and address:

Haltian Oy
Yrttipellontie 1 D
90230 Oulu
Finland

FCC REQUIREMENTS FOR OPERATION IN THE UNITED STATES

FCC Information for the User

This product does not contain any user serviceable components and is to be used with approved, internal antennas only. Any product changes or modifications will invalidate all applicable regulatory certifications and approvals.

FCC Guidelines for human Exposure

This equipment complies with FCC radiation exposure limits set forth for an uncontrolled environment. This equipment should be installed and operated with minimum distance of 20 cm between the radiator and your body. This transmitter must not be co-located or operating in conjunction with any other antenna or transmitter.

FCC Radio Frequency Interference Warnings & Instructions

This equipment has been tested and found to comply with the limits for a Class B digital device, pursuant to Part 15 of the FCC Rules. These limits are designed to provide reasonable protection against harmful interference in a residential installation. This equipment uses and can radiate radio frequency energy and, if not installed and used in accordance with the instructions, may cause harmful interference to radio communications. However, there is no guarantee that interference will not occur in a particular installation. If this equipment does cause harmful interference to radio or television reception, which can be determined by turning the equipment off and on, the user is encouraged to try to correct the interference by one or more of the following methods:

Increase the separation between the equipment and the receiver.

Connect the equipment into an electrical outlet on a circuit different from that which the radio receiver is connected

Consult the dealer or an experienced radio/TV technician for help

Any changes or modifications not expressly approved by the party responsible for compliance could void the user's authority to operate this equipment.

FCC compliance statement:

This device complies with Part 15 of the FCC Rules. Operation is subject to the following two conditions: (1) this device may not cause harmful interference, and (2) this device must accept any interference received, including interference that may cause undesired operation.

Innovation, Science and Economic Development Canada (ISED) regulatory information

This device complies with RSS-247 of the Innovation, Science and Economic Development Canada (ISED) Rules. Operation is subject to the following two conditions: (1) This device may not cause harmful interference, and (2) this device must accept any interference received, including interference that may cause undesired operation.

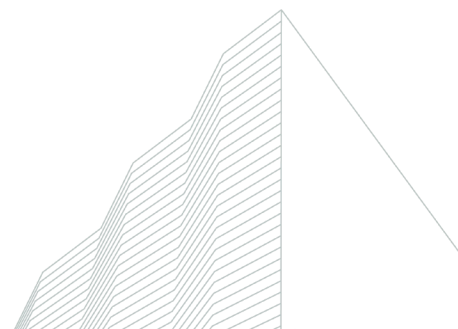

Ce dispositif est conforme à la norme CNR-247 d'Innovation, Sciences et Développement économique Canada applicable aux appareils radio exempts de licence. Son fonctionnement est sujet aux deux conditions suivantes: (1) le dispositif ne doit pas produire de brouillage préjudiciable, et (2) ce dispositif doit accepter tout brouillage reçu, y compris un brouillage susceptible de provoquer un fonctionnement indésirable

Radiation Exposure Statement :

This device complies with ISED radiation exposure limits set forth for an uncontrolled environment. This equipment must be installed and used with a minimum distance of 20 cm between the radiator and your body.

NOTE IMPORTANTE: Déclaration d'exposition aux radiations:

Cet équipement est conforme aux limites d'exposition aux rayonnements ISED établies pour un environnement non contrôlé. Cet équipement doit être installé et utilisé avec une distance minimale de 220 cm entre le radiateur et votre corps.

FCC ID: 2AEU3TSPRE

IC ID: 20236-TSPRE

RCM-approved for Australia and New Zealand.

IMDA-approved for Singapore.

Modelo: ANATEL: 04471-24-16620

Para maiores informações, consulte o site da ANATEL www.gov.br/anatel/pt-br

Este equipamento não tem direito à proteção contra interferência prejudicial e não pode causar interferência em sistemas devidamente autorizados. Este produto não é apropriado para uso em ambientes domésticos, pois poderá causar interferências eletromagnéticas que obrigam o usuário a tomar medidas necessárias para minimizar estas interferências.

La operación de este equipo está sujeta a las siguientes dos condiciones: (1) es posible que este equipo o dispositivo no cause interferencia perjudicial y (2) este equipo o dispositivo debe aceptar cualquier interferencia, incluyendo la que pueda causar su operación no deseada.

No se recomienda el uso de este producto a una distancia menor a 20cm del cuerpo humano.

SAFETY GUIDE

Read these simple guidelines. Not following them may be dangerous or against local laws and regulations. For further information, read the user guide and visit www.haltian.com

Usage

Do not cover the device as it prevents the device from operating properly.

- This product is intended for indoor use only and shall not be exposed to rain.
- Do not modify the device. Unauthorized modifications may damage the device and violate regulations governing radio devices.
- Do not store the device in wet or humid conditions.
- Remove the batteries from the device if you are taking it inside an aeroplane (unless you have the pre-installed pull-out tape still in place). The device has a Bluetooth LE receiver/transmitter which must not be operational during a flight.
- Please take care that the used batteries are recycled by taking them to appropriate collection point.
- When changing batteries, replace both of them at the same time using identical brand and type.
- Do not swallow batteries.
- Do not throw batteries into water or fire.
- Do not short-circuit batteries.
- Do not try to charge primary batteries.
- Do not open or disassemble batteries.
- Batteries should be stored in a dry place and at room temperature. Avoid large temperature changes and direct sunlight.

At higher temperature the electrical performance of the batteries may be reduced.

- Keep batteries away from children.

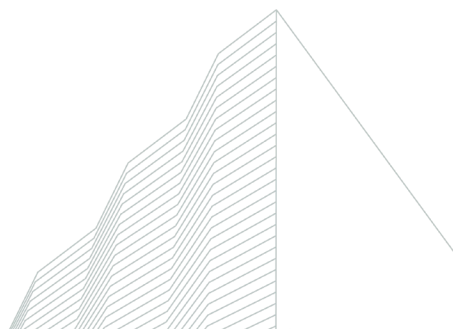

Care and maintenance

Handle your device with care. The following suggestions help you keep your device operational.

- Do not open the device other than as instructed in the user guide.
- Unauthorized modifications may damage the device and violate regulations governing radio devices.
- Do not drop, knock, or shake the device. Rough handling can break it.
- Only use a soft, clean, dry cloth to clean the surface of the device. Do not clean the device with solvents, toxic chemicals or strong detergents as they may damage your device and void the warranty.
- Do not paint the device. Paint can prevent proper operation.

Damage

If the device is damaged contact support@haltian.com. Only qualified personnel may repair this device.

Small children

Your device is not a toy. It may contain small parts. Keep them out of the reach of small children.

RECYCLING

Check the local regulations for proper disposal of electronic products. The Directive on Waste Electrical and Electronic Equipment (WEEE), which entered into force as European law on 13th February 2003, resulted in a major change in the treatment of electrical equipment at end-of-life. The purpose of this Directive is, as a first priority, the prevention of WEEE, and in addition, to promote the reuse, recycling and other forms of recovery of such wastes so as to reduce disposal.

The crossed-out wheelie-bin symbol on your product, battery, literature, or packaging reminds you that all electrical and electronic products and batteries must be taken to separate collection at the end of their working life. Do not dispose of these products as unsorted municipal waste: take them for recycling. For info on your nearest recycling point, check with your local waste authority.

Complies with
IMDA Standards
DA103787



1. Equipment name, Model name: Thingsee PRESENCE / TPR
2. Registration No: R-R-2ae-TPR
3. Applicant name: Haltian Oy
4. Manufacture date: 2024
5. Manufacturer / Country of Origin: Haltian Oy / Finland

Sensor Inalámbrico (Thingsee PRESENCE)

Marca: Thingsee
Modelo: TPR
Fabricante: Haltian Oy
2 pilas alcalinas AAA
Hecho en Finlandia
Certification number: CETHTP24-27108



Innovation, Science and
Economic Development Canada

Innovation, Sciences et
Développement économique Canada



Get to know all our Haltian devices



Thingsee
PRESENCE



Thingsee
ENVIRONMENT



Thingsee ENVIRONMENT
RUGGED



Thingsee LEAKAGE
RUGGED

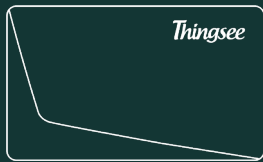

Thingsee
AIR



Thingsee
BEAM

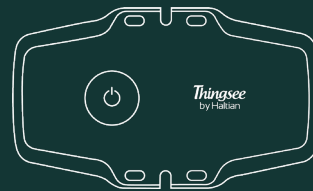

Thingsee GATEWAY
GLOBAL

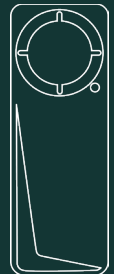

Haltian
RADAR

For all devices and more information, visit our website
www.haltian.com or contact sales@haltian.com

