

# Thingsee

## POWERCOVER

### Quick Guide



- 1.** Pull away the battery security tab and the device is ready for use.

Security tab

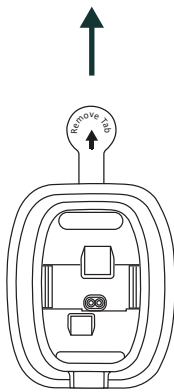

- 2.** To assemble a sensor, remove its bottom cover and batteries. The sensor can then be snapped to its place on top of Thingsee POWERCOVER.

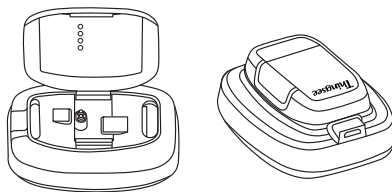

- 3.** To open Thingsee POWERCOVER, place the opening key to the slot between the covers and bend the key away from the device.

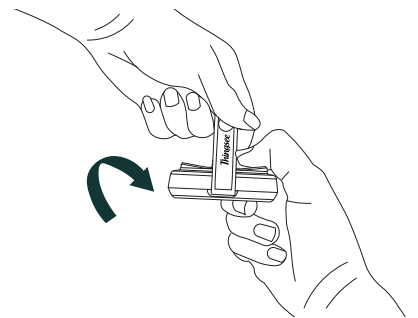

- 4.** To remove the sensor from Thingsee POWERCOVER, remove the batteries first. Place the straight end of the Opening Key to the slot inside the cover. Push the tool towards the sensor and the sensor is released.

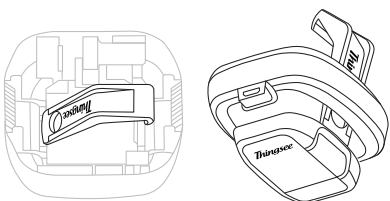

- 5.** Clean the installation surface with IPA solvent.

Surface

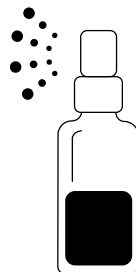

- 6.** Remove the tape's paper cover. Install the cover to the designated location by pushing firmly for a minimum of 5 seconds.

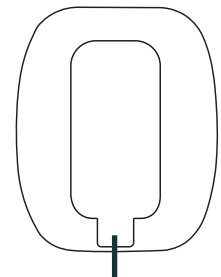

Tape with paper cover

Continue to read the detailed installation instructions.

Watch installation video here



# *Thingsee* POWERCOVER

User and Installation Guide

v.24.02

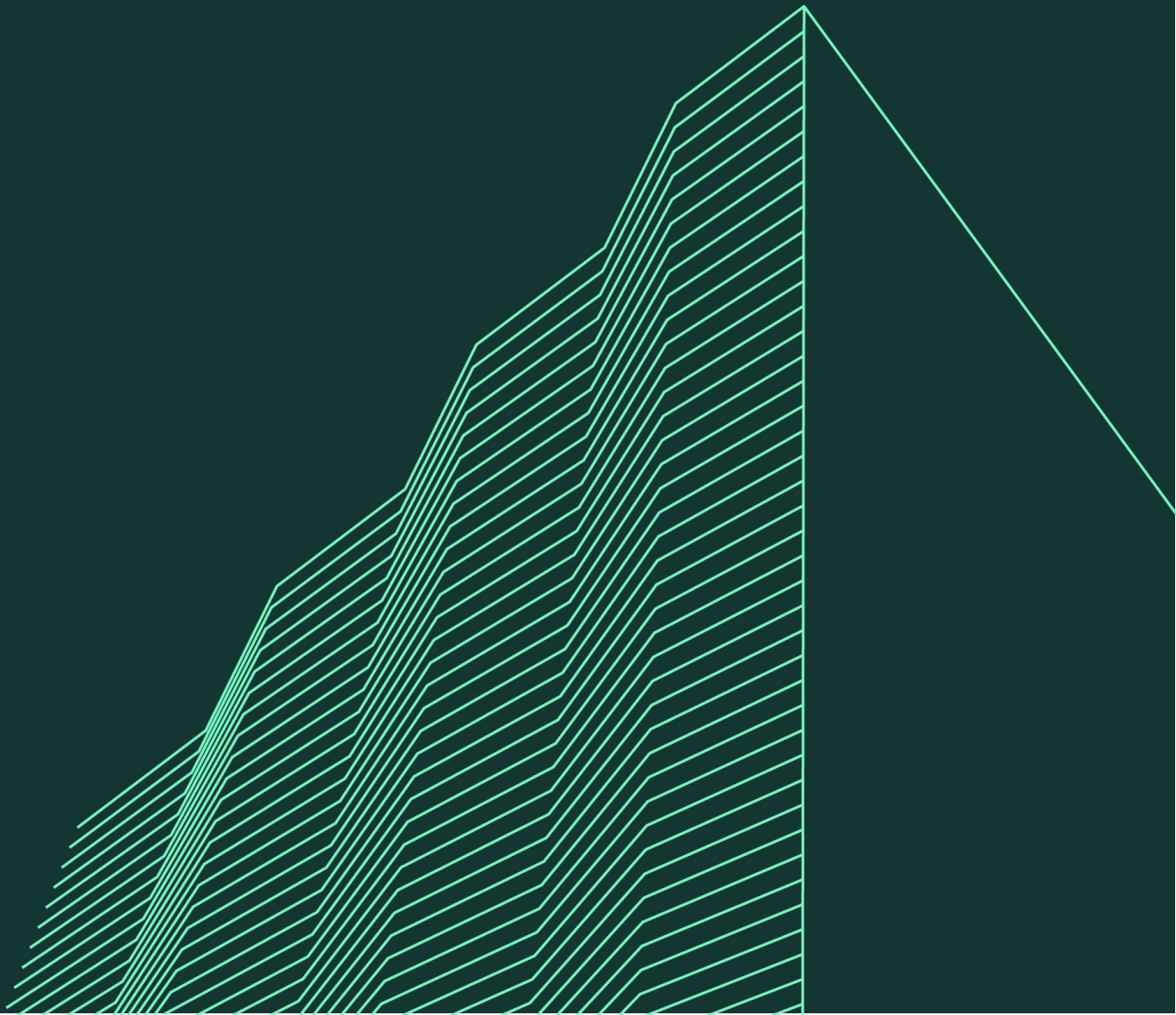

# Welcome to using Haltian Thingsee

We at Haltian want to make IoT simple, so we have created a solution that is easy to use, scalable, and secure. I hope it will help you achieve your business goals!

Pasi Leipälä  
CEO, Haltian Oy

## Thingsee POWERCOVER



Thingsee POWERCOVER is a power supply accessory for selected Thingsee sensor devices. It can be powered through either batteries or a USB-power cable. Thingsee POWERCOVER provides extended battery life for wireless sensor devices for up to 10 years. This device can be used in various IoT use cases where extremely long battery life is needed.

## Sales package content

- Thingsee POWERCOVER
- 3 x AA batteries (pre-installed, replaceable)

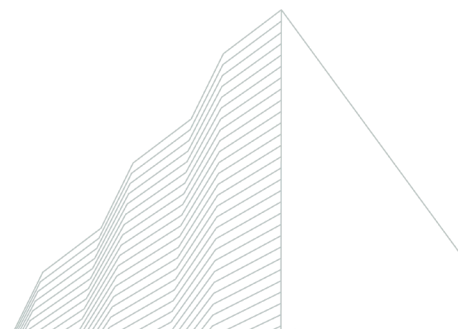

# Using Thingsee POWERCOVER

Thingsee POWERCOVER can be used as a power source for the following Thingsee sensor devices: Thingsee PRESENCE, Thingsee ENVIRONMENT and Thingsee DISTANCE, in cases where extremely long operating time without battery change is needed.

Thingsee POWERCOVER works with 3 AA Lithium batteries which provide Thingsee sensor devices up to 10 years of battery life.

In addition to the battery power, Thingsee POWERCOVER can be powered through a micro-USB connector for continuous power and unlimited operational time. This device can be used in various IoT use cases where extremely long battery life is needed. For example, high ceilings and other hard to reach locations are ideal for this accessory.

When available, the Thingsee POWERCOVER will prefer the USB-power and switches to that from the battery power. It will also switch back to the battery power if the micro-USB power is lost. This provides extra power security during possible power outbreaks. Note that Thingsee POWERCOVER does not support battery charging.

## General installation instructions

Thingsee POWERCOVER is installed to the desired place with a double sided tape. The installation placement depends on the sensor that is used with the Thingsee POWERCOVER.

Thingsee POWERCOVER can be delivered either with the sensor device already installed to the Thingsee POWERCOVER or without it.

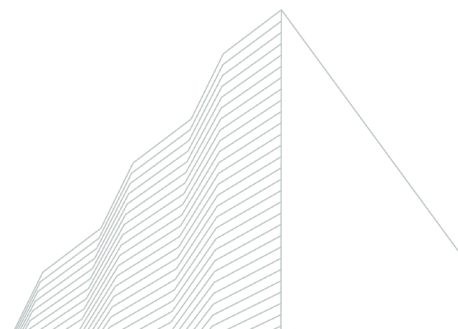

# Things to avoid in installation

Avoid installing the Thingsee products near the following:

- 1.** Thick concrete structures or thick fire doors.

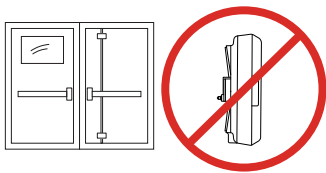

- 2.** Electrical transformers or thick electrical wires.

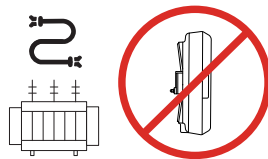

- 3.** Escalators.



- 4.** Nearby heating or cooling devices and/or vents.

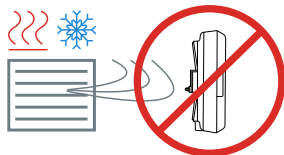

- 5.** Direct sun light.

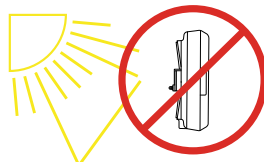

- 6.** Nearby halogen lamps, fluorescent lamps or similar lamps with hot surface.

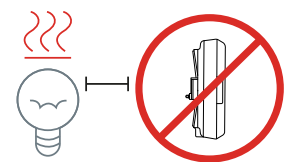

- 7.** Inside or underneath a metal cabinet or box.



- 8.** Near elevator motors or similar targets causing a strong magnetic field.

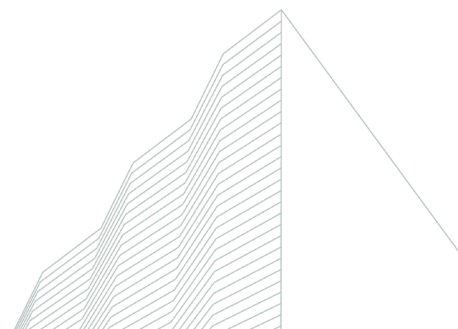
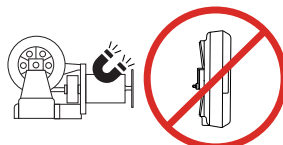

# Installation

Thingsee POWERCOVER is delivered with batteries assembled inside. Pull away the battery security tab and the device is ready for use.

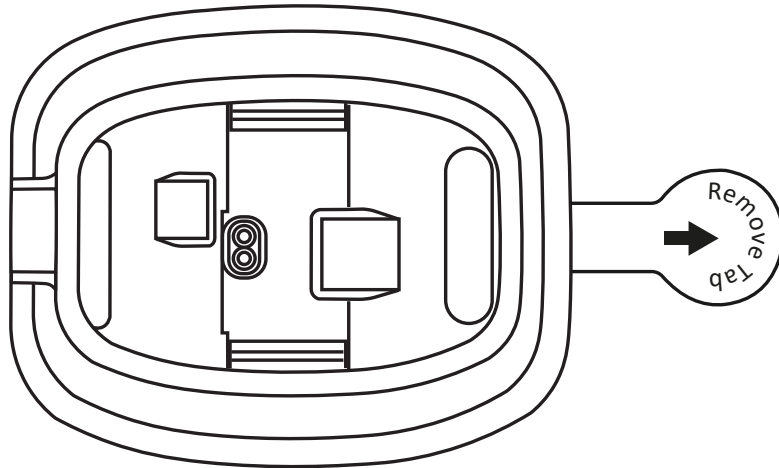

Thingsee POWERCOVER can be delivered either with the sensor pre-assembled or without the sensor device. If you need to assemble a sensor to Thingsee POWERCOVER, first remove the bottom cover and batteries from the sensor. The sensor can then be just snapped to its place on top of Thingsee POWERCOVER. Make sure that the direction of the sensor is correct for assembly. After snapping to its place, the sensor is ready for use.

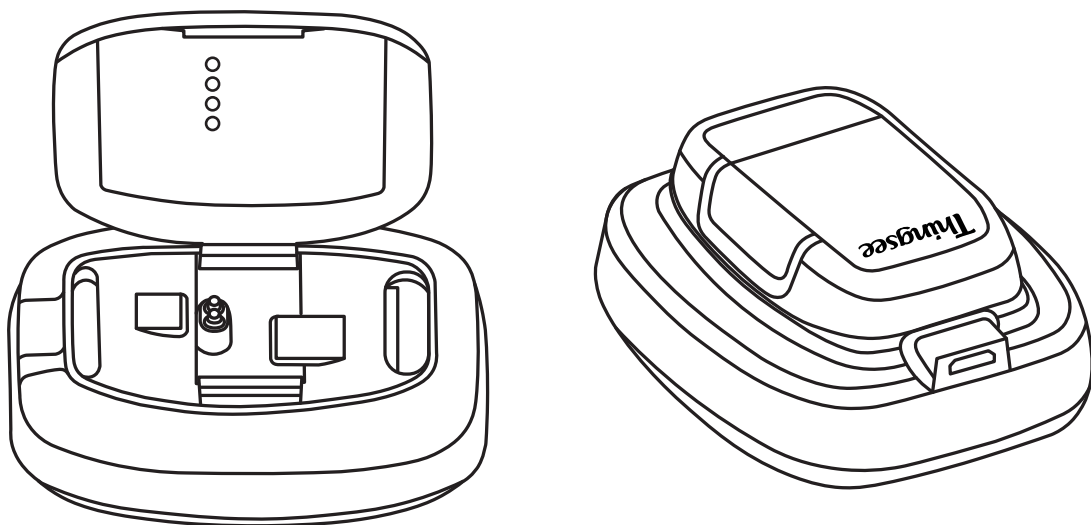

If you need to open the device (e.g. for changing the batteries), use the opening key provided with the device.

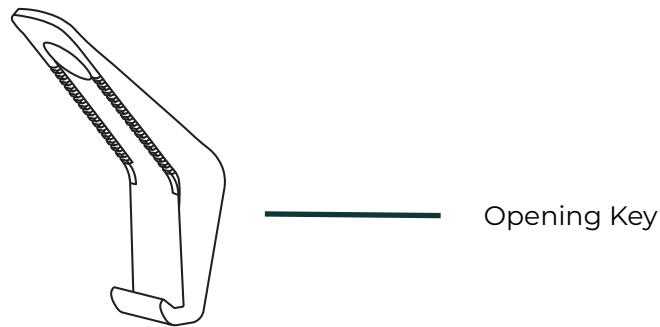

Place the opening key to the slot between Thingsee POWERCOVER covers and bend the key away from the device.

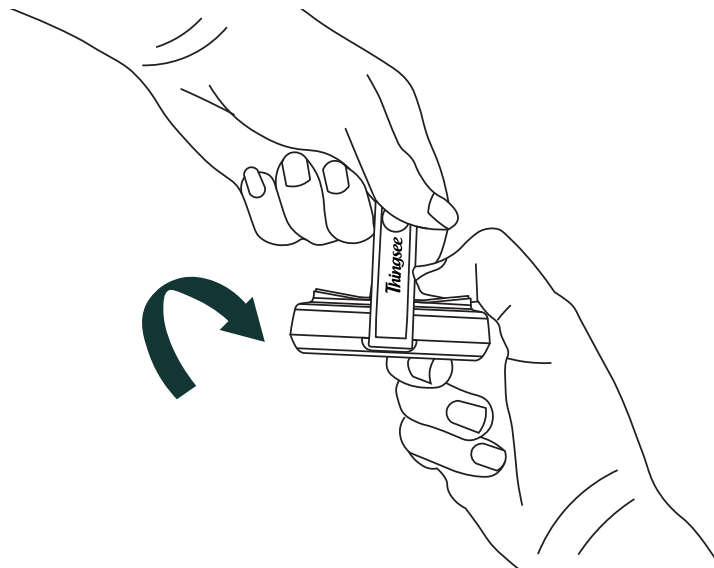

If you change the batteries, please use Lithium batteries to ensure correct functionality. The recommended battery type is Energizer® Ultimate Lithium. When placing the bottom cover back, please note the correct direction of the cover.

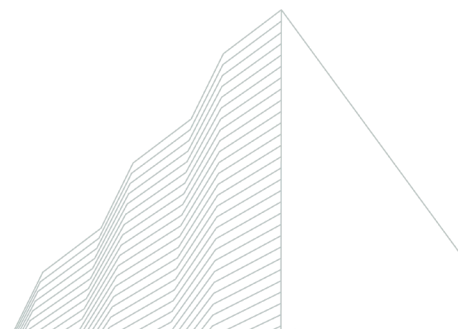
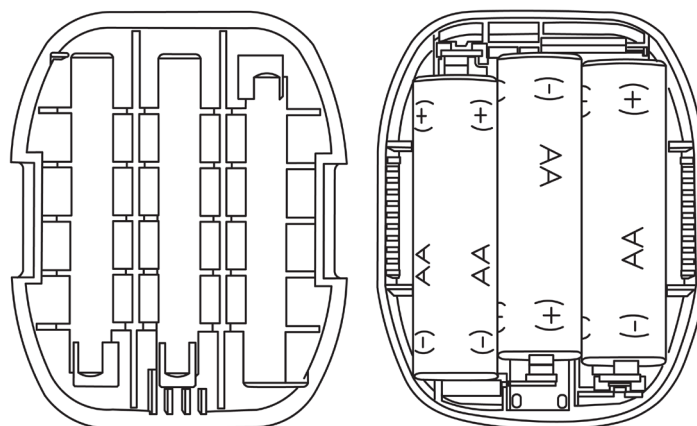

If you want to remove the sensor from the Thingsee POWERCOVER, remove the batteries first. Place the straight end of the Opening Key to the slot inside the Thingsee POWERCOVER. Push the tool towards the sensor and the sensor is released.

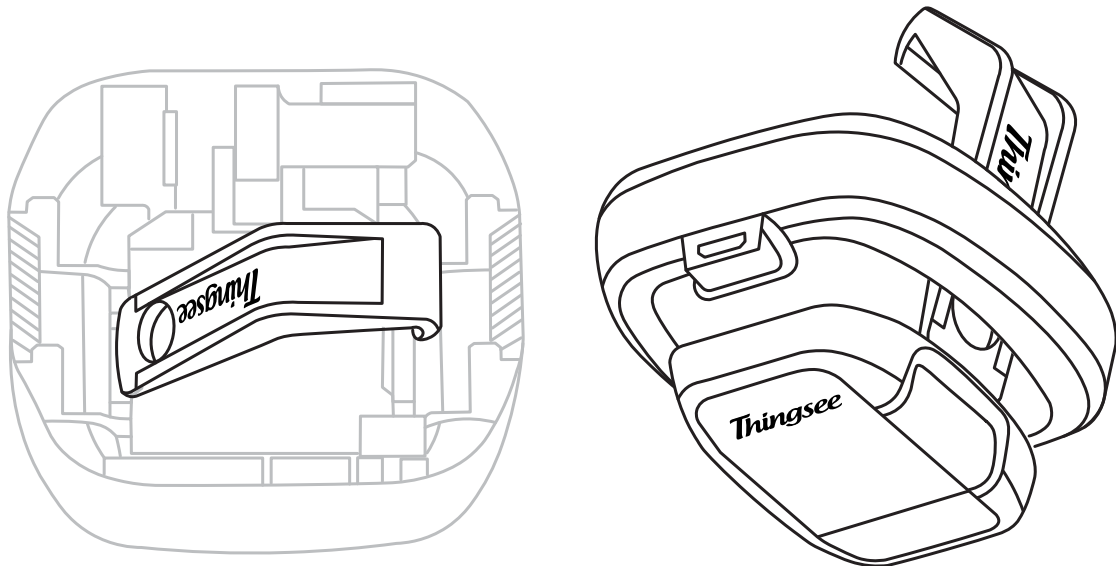

The double-sided tape at the bottom of the device can be used for attachment.

Remove the tape cover and attach the device to a clean, flat surface by pushing firmly for minimum of 5 seconds.

Use IPA solvent (isopropyl alcohol) to clean the attachment surface before installation.

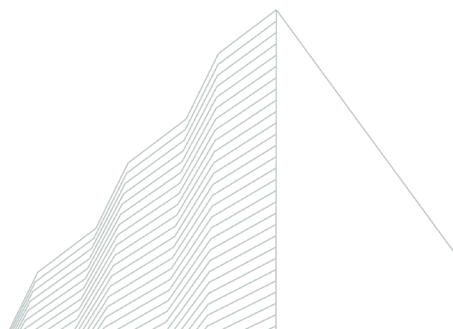
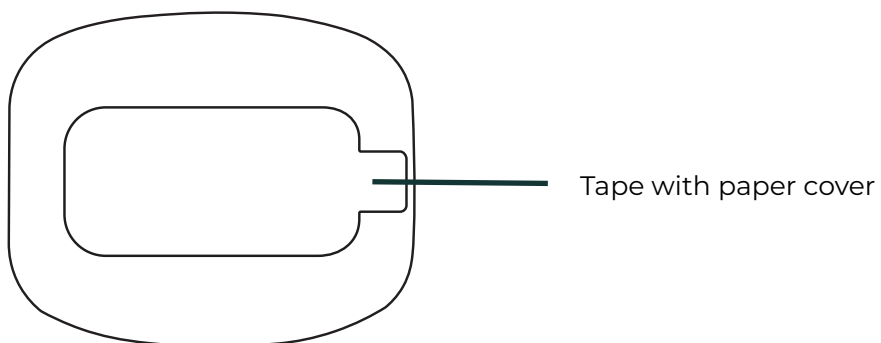



If you want to ensure the attachment with screws, you can use an accessory available separately from Haltian Products.

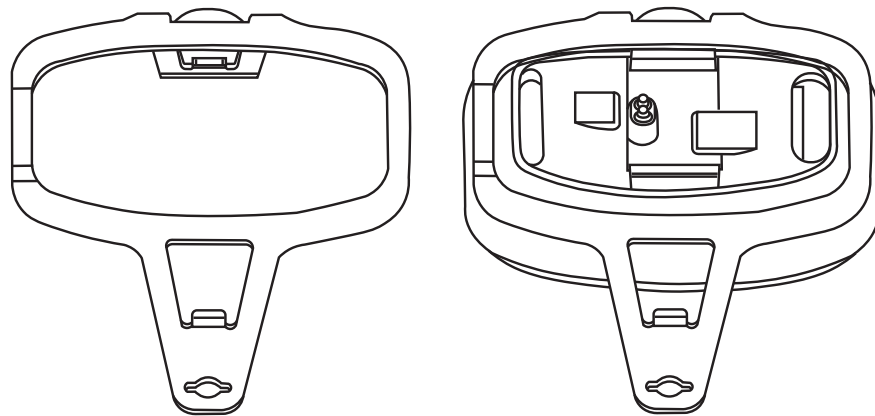

## Using micro-USB power source

The recommended micro-USB power source is Sunny SYS1381N-1205-W2E (for Europe).

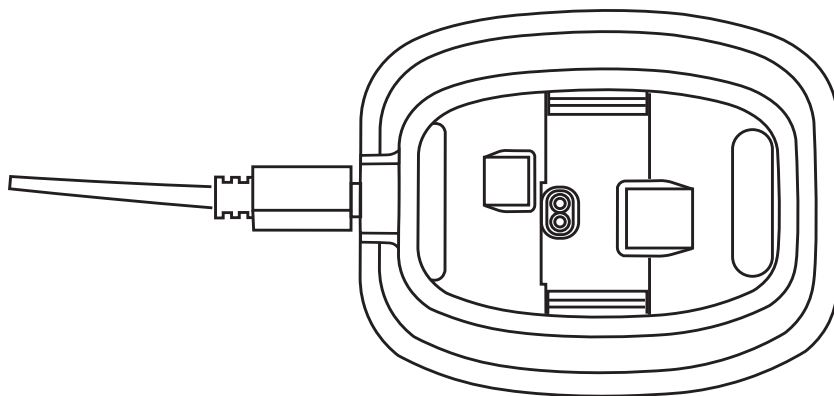

## Default measurement and reporting

Thingsee sensor devices notify Thingsee Operations device management system on the following:

- if they are using Thingsee POWERCOVER.
- Thingsee POWERCOVER battery status.
- Used power source (batteries or USB-cable).

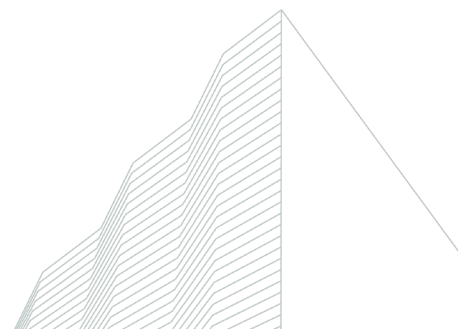

# Device info

Operating temperature -20°C ... +50°C

Operating humidity 0% ... 100% RH non-condensing

Storage temperature +5°C ... +25°C

Storage humidity 45% ... 85% RH non-condensing

IP rating grade: IP40

Certifications: CE, FCC, ISED, RoHS, UKCA and NOM + NYCE, IFT compliant

Battery type: 3 x AA primary lithium, replaceable, non-chargeable

Expected battery life up to 10 years

MicroUSB for power supply at 5 V  $\pm$  5% / 500mA

More device info can be found at [support.haltian.com](https://support.haltian.com)

# Device dimensions

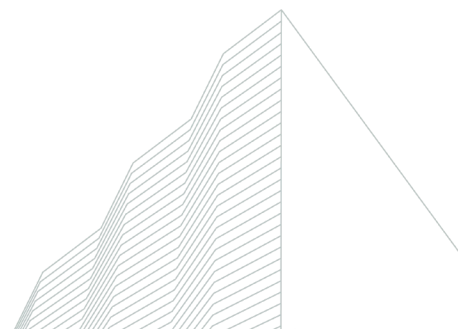
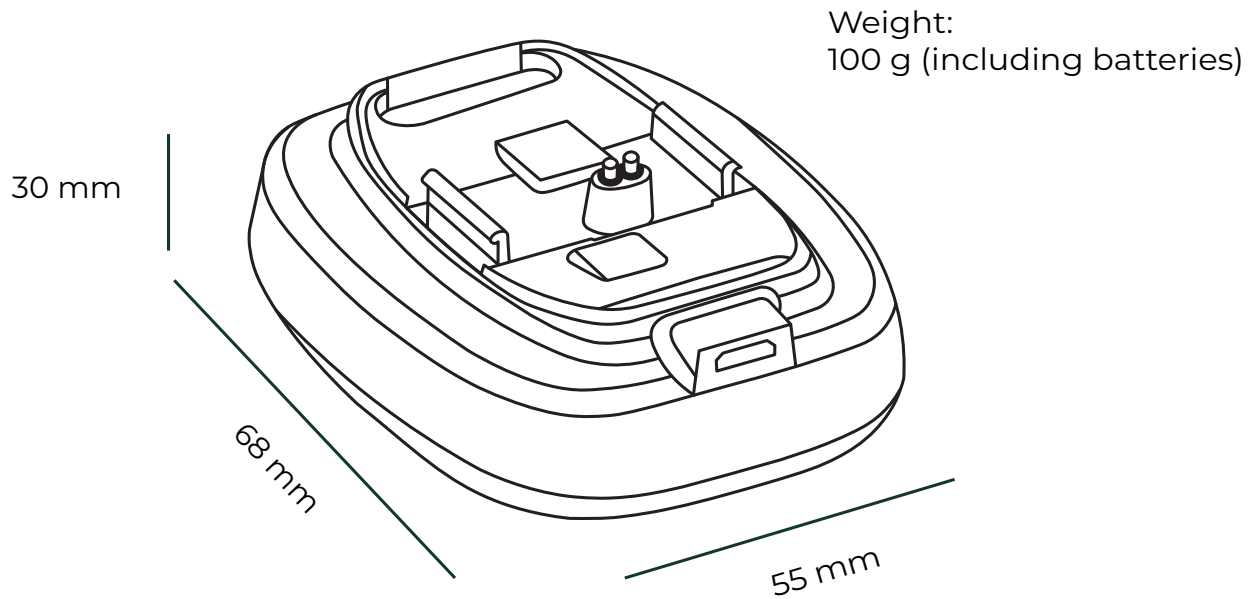

CERTIFICATION INFORMATION  
EU DECLARATION OF CONFORMITY

Hereby, Haltian Oy declares that the equipment type TSPC is in compliance with Directive 2014/53/EU.  
The full text of the EU declaration of conformity is available at the following internet address: [support.haltian.com](http://support.haltian.com)

Haltian Oy vakuuttaa, että laitetyyppi TSPC on direktiivin 2014/53/EU mukainen. EU-vaatimustenmukaisuusvakuutuksen täysimittainen teksti on saatavilla seuraavassa internetosoitteessa: [support.haltian.com](http://support.haltian.com)

Hereby, Haltian Oy declares that the radio equipment type TSPC is in compliance with the UK relevant statutory requirements (Radio Equipment Regulations 2017 (SI 2017 No. 1206)). The full text of the declaration of conformity is available at the following internet address: [support.haltian.com](http://support.haltian.com)

Manufacturer name and address:

Haltian Oy  
Yrttpellontie 1 D  
90230 Oulu  
Finland

FCC REQUIREMENTS FOR OPERATION IN THE UNITED STATES

Suppliers Declaration of Conformity

This Declaration of Conformity is hereby issued according to Chapter 1, Subpart A, Part 2 of Title 47 of the Code of Federal Regulations by: Haltian Oy, Yrttpellontie 1 D, 90230 Oulu, Finland.

The product Thingsee Power Cover/TSPC complies with the applicable requirements of FCC Rule Part 15.

RESPONSIBLE PARTY located in the United States: Violette Engineering Corporation, 6731 Whittier Avenue, McLean, VA 22101, [info@violettecorp.com](mailto:info@violettecorp.com).

The responsible party warrants that each unit of equipment marketed under this Declaration of Conformity will be identical to the unit tested and found acceptable with the standards and that the records maintained by the responsible party continue to reflect the equipment being produced under such Supplier's Declaration of Conformity continue to comply within the variation that can be expected due to quantity production and testing on a statistical basis.

Industry Canada

Industry Canada Compliance Statement: This Class B digital apparatus complies with Canadian ICES-003.

Avis de conformité à la réglementation d'Industrie Canada: Cet appareil numérique de la classe B est conforme à la norme NMB-003 du Canada.

La operación de este equipo está sujeta a las siguientes dos condiciones: (1) es posible que este equipo o dispositivo no cause interferencia perjudicial y (2) este equipo o dispositivo debe aceptar cualquier interferencia, incluyendo la que pueda causar su operación no deseada.

No se recomienda el uso de este producto a una distancia menor a 20cm del cuerpo humano.

SAFETY GUIDE

Read these simple guidelines. Not following them may be dangerous or against local laws and regulations. For further information, read the user guide and visit [www.haltian.com](http://www.haltian.com)

Usage

- TSPC is intended for indoor use only and shall not be exposed to rain.
- Please take care that the used batteries are recycled by taking them to appropriate collection point.
- When changing batteries, replace all of them at the same time using identical brand and type.
- Do not swallow batteries.
- Do not throw batteries into water or fire.
- Do not short-circuit batteries.
- Do not try to charge primary batteries.
- Do not open or disassemble batteries.
- Batteries should be stored in a dry place and at room temperature. Avoid large temperature changes and direct sunlight. At higher temperature the electrical performance of the batteries may be reduced.
- Keep batteries away from children.

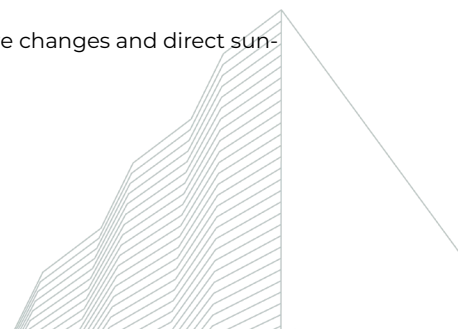

## Care and maintenance

Handle your device with care. The following suggestions help you keep your device operational.

- Do not open the device.
- Unauthorized modifications may damage the device and violate regulations governing radio devices.
- Do not drop, knock, or shake the device. Rough handling can break it.
- Only use a soft, clean, dry cloth to clean the surface of the device. Do not clean the device with solvents, toxic chemicals or strong detergents as they may damage your device and void the warranty.
- Do not paint the device. Paint can prevent proper operation.

## Damage

If the device is damaged contact [support@haltian.com](mailto:support@haltian.com). Only qualified personnel may repair this device.

## Small children

Your device is not a toy. It may contain small parts. Keep them out of the reach of small children.

## RECYCLING

Check the local regulations for proper disposal of electronic products. The Directive on Waste Electrical and Electronic Equipment (WEEE), which entered into force as European law on 13th February 2003, resulted in a major change in the treatment of electrical equipment at end-of-life. The purpose of this Directive is, as a first priority, the prevention of WEEE, and in addition, to promote the reuse, recycling and other forms of recovery of such wastes so as to reduce disposal.

The crossed-out wheelie-bin symbol on your product, battery, literature, or packaging reminds you that all electrical and electronic products and batteries must be taken to separate collection at the end of their working life. Do not dispose of these products as unsorted municipal waste: take them for recycling. For info on your nearest recycling point, check with your local waste authority.

### Cubierta de Energia (Thingsee POWERCOVER)

**Marca:** Thingsee

**Modelo:** TSPC

**Fabricante:** Haltian Oy

3 pilas de litio AA

Hecho en Finlandia

**Certification number:** NYC-2402C0E13507



Innovation, Science and  
Economic Development Canada

Innovation, Sciences et  
Développement économique Canada



# Get to know all our Haltian devices



Thingsee  
PRESENCE



Thingsee  
ENVIRONMENT



Thingsee ENVIRONMENT  
RUGGED



Thingsee LEAKAGE  
RUGGED



Thingsee  
AIR



Thingsee  
BEAM

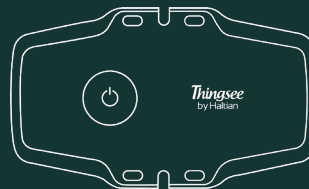

Thingsee GATEWAY  
GLOBAL



Haltian  
RADAR

For all devices and more information, visit our website  
[www.haltian.com](http://www.haltian.com) or contact [sales@haltian.com](mailto:sales@haltian.com)

