

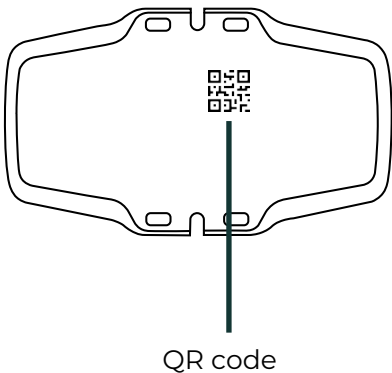

- 1.** Identify the sensor by reading the QR code on the backside of the device.

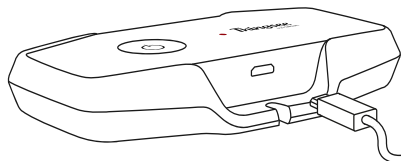

- 2.** Connect the power source to the gateway and plug it into a wall socket with 24/7 power.



- 3.** Thingsee GATEWAY GLOBAL is always cellular connected: LED indication is used to provide gateway status information. The LED on top of the device starts to blink:

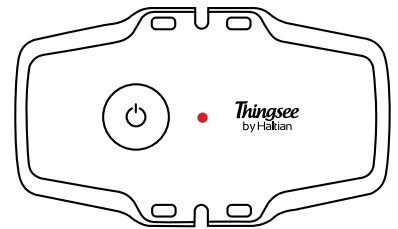

- 4.**
- RED blink – device is connecting to mobile network
 - RED/GREEN blink – device is connecting to Thingsee cloud
 - GREEN blink – device is connected to the mobile network and Thingsee cloud and is operating correctly

To close the device press the Power button for 3 seconds. When released, device starts the shutdown process, red LED indication 5 times during a 2 second period. When in shutdown state, no LED indication.
To restart the device press the power button once and the LED sequence starts again.



Thingsee GATEWAY GLOBAL

User and Installation Guide

v.24.04

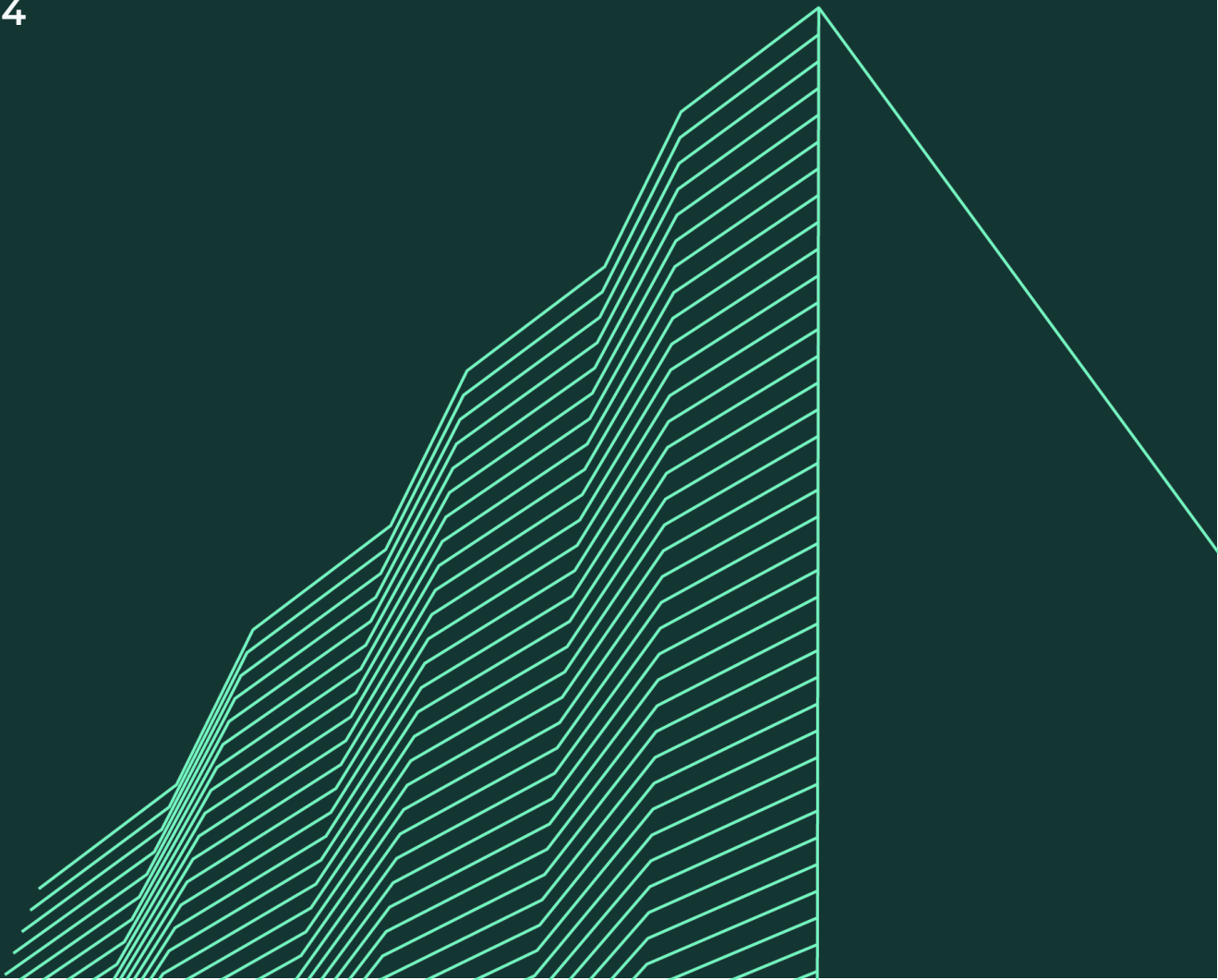

Welcome to using Haltian Thingsee

We at Haltian want to make IoT simple, so we have created a solution that is easy to use, scalable, and secure. I hope it will help you achieve your business goals!

Pasi Leipälä
CEO, Haltian Oy

Thingsee GATEWAY GLOBAL



Thingsee GATEWAY GLOBAL is a plug & play IoT gateway device for large scale IoT solutions. It can be connected anywhere in the world with its LTE Cat M1 and 2G cellular support. The main role of Thingsee GATEWAY GLOBAL is to ensure that data flows continuously, reliably and safely from the sensors to the cloud.

Thingsee GATEWAY GLOBAL connects a mesh of a few to hundreds of wireless sensor devices to Thingsee Operations Cloud. It exchanges data with the mesh network and sends data to cloud backends.

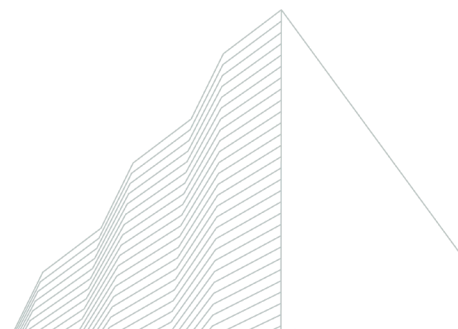

Sales package content

- Thingsee GATEWAY GLOBAL
Includes SIM card and managed SIM subscription
- Power supply unit (micro-USB)
- 'Do Not Unplug' sticker for the power cord

Note before installation

Install the gateway to a secure location. In public places, install the gateway behind locked doors.

To ensure strong enough signal strength for data delivery, keep the maximum distance between mesh network devices under 20 m.

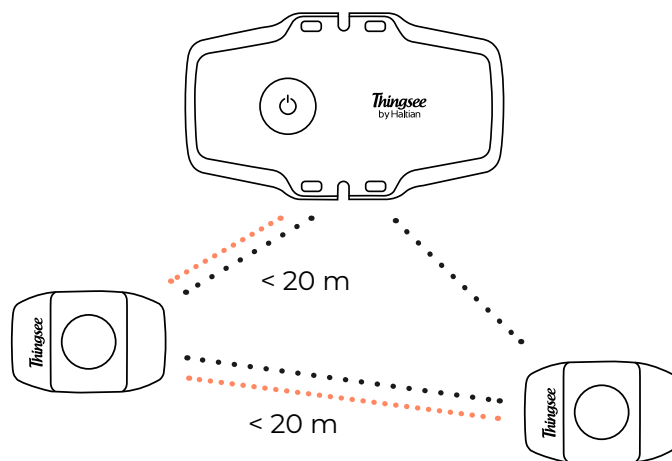

If the distance between a measuring sensor and the gateway is $> 20\text{m}$ or if the sensors are separated by a fire door or other thick building materials, use extra sensors as routers.

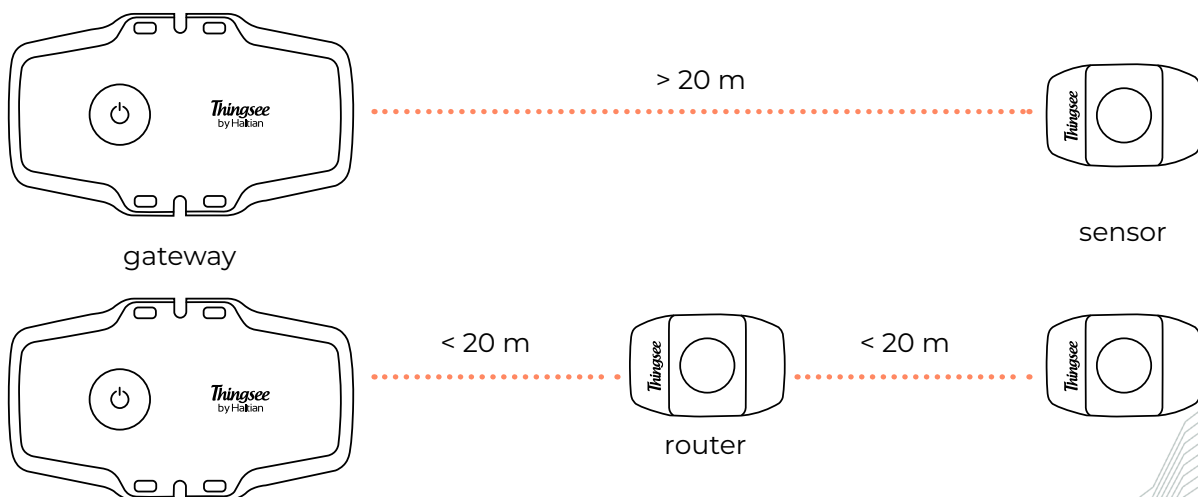

Thingsee installation network structure

Thingsee devices build a network automatically. Devices communicate all the time to adjust the network structure for effective data delivery.

Sensors create subnetworks for data delivery by choosing the best possible route based on signal strength. The subnetwork chooses the strongest possible gateway connection for data delivery to the cloud.

The customer network is closed and secure. It cannot be harmed by third party connections.

..... Network communication

..... Data flow

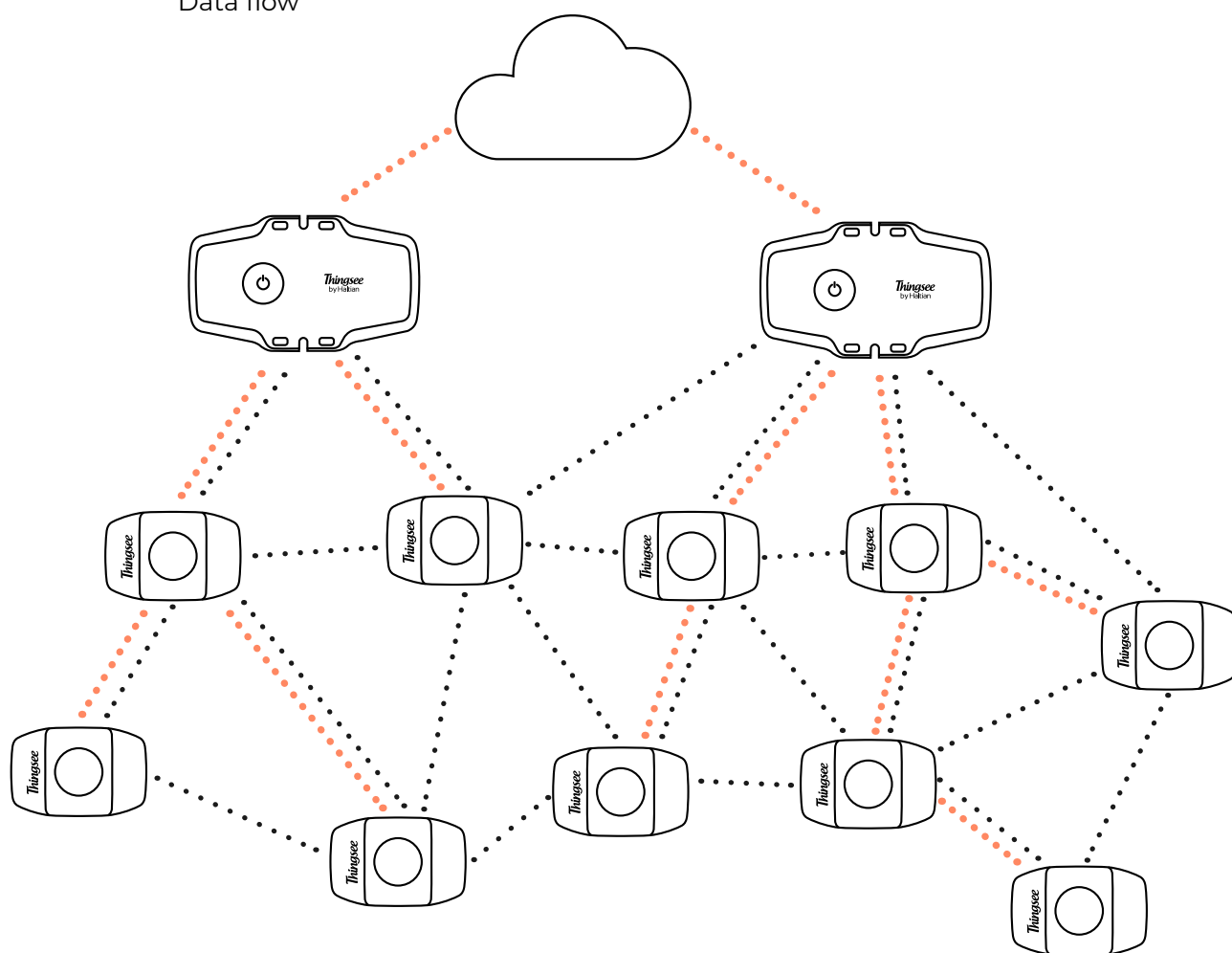

The amount sensors per one gateway varies depending on the sensors' reporting time: the longer the reporting time, the more sensor can be connected to one gateway. The usual amount is from 50-100 sensors per gateway to even up to 200 sensors.

To ensure mesh network data flow, a second gateway can be installed on the other side of the installation site.

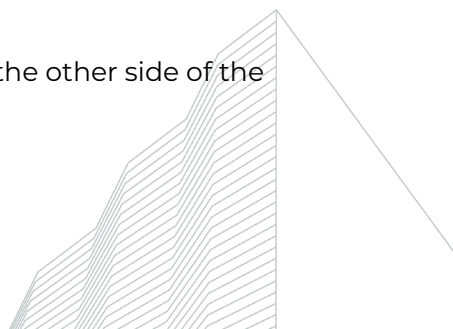

Things to avoid in installation

Avoid installing the Thingsee products near the following:

1. Escalators

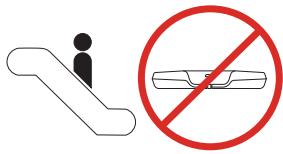

2. Electrical transformers or thick electrical wires

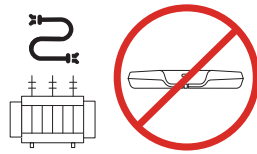

3. Nearby halogen lamps, fluorescent lamps or similar lamps with hot surface

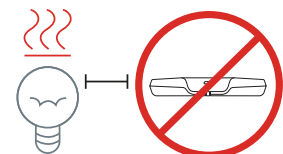

4. Thick concrete structures or thick fire doors

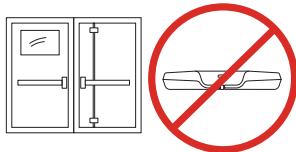

5. Nearby radio equipment like WiFi routers or any other similar high power RF transmitters

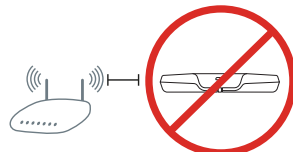

6. Inside metal box or covered with a metal plate

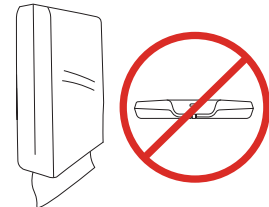

7. Inside or underneath a metal cabinet or box

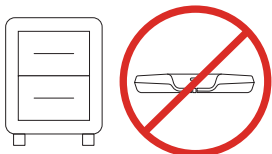

8. Near elevator motors or similar targets causing a strong magnetic field

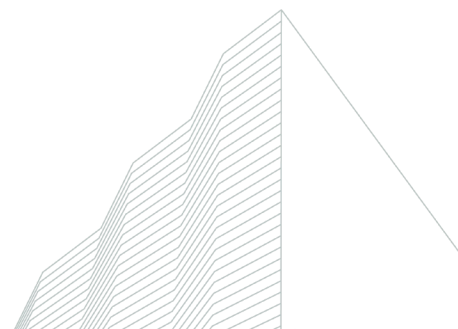
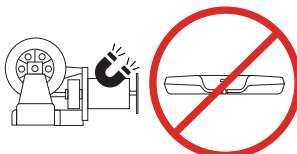

Data integration

Make sure that data integration has been properly setup prior to the installation process. See link <https://support.haltian.com/howto/aws/>

Thingsee data can be pulled (subscribed) from the Thingsee Cloud live data stream, or the data can be pushed to your defined end point (e.g. Azure IoT Hub before you install the sensors.)

Installation

Before installing the sensors, make sure the Thingsee gateway device is installed and connected to a mobile network (LED blinking green).

To identify the gateway, read the QR code on the backside of the device with a QR code reader or Thingsee Toolbox application on your mobile device.

Identifying the device is not necessary, but it will help you keep track of your IoT installation and help Haltian support to solve possible issues.

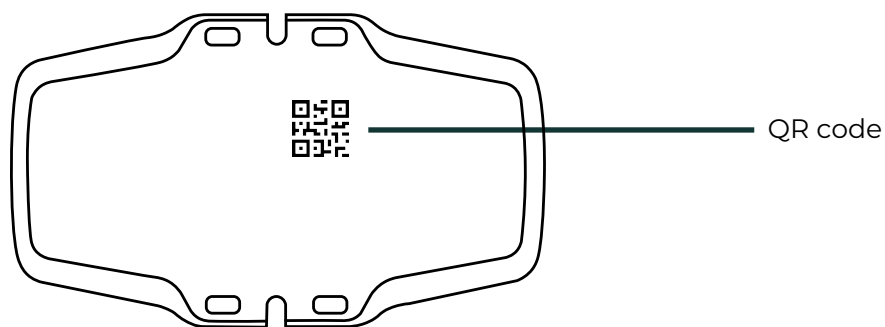

To identify the device over Thingsee API, please follow the link for further information:

<https://support.haltian.com/api/open-services-api/api-sequences/>

Connect the power source to the gateway and plug it into a wall socket with 24/7 power. Do not unplug the device to avoid disrupting the IoT system and causing data loss.

Note: always use the power source included in the sales package.

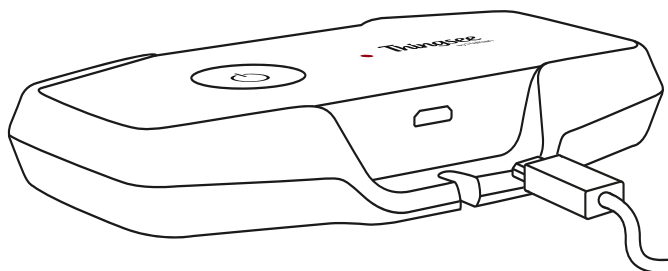

To prevent someone from accidentally unplugging the gateway, attach the 'Do Not Unplug' sticker to the power cord to a visible place near the socket.

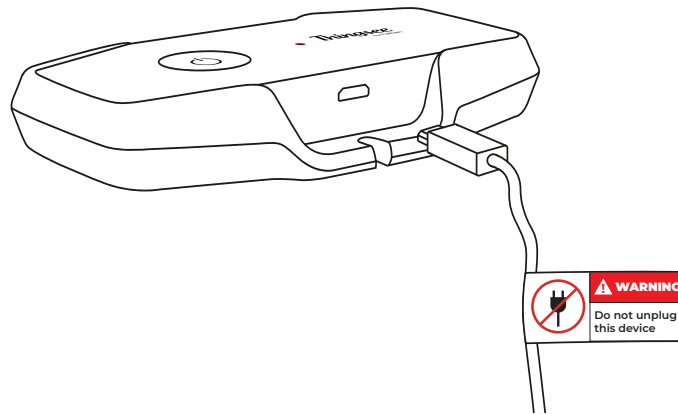

Thingsee GATEWAY GLOBAL is always cellular connected:
LED indication is used to provide gateway status information.

The LED on top of the device starts to blink:

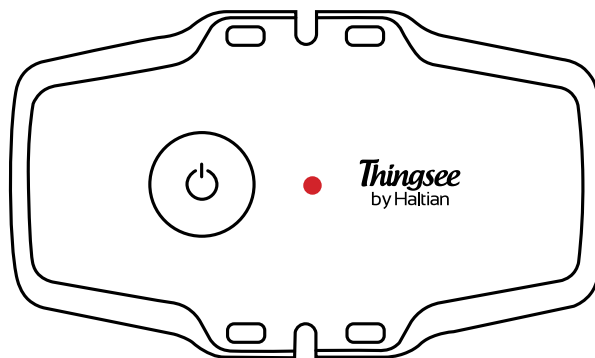

RED blink – device is connecting to mobile network



RED/GREEN blink – device is connecting to Thingsee cloud



GREEN blink – device is connected to the mobile network and Thingsee cloud and is operating correctly



To close the device press the Power button for 3 seconds.

When released, the device starts the shutdown process, red LED indication 5 times during a 2 second period. When in shutdown state, no LED indication. To restart the device press the power button once and the LED sequence starts again.

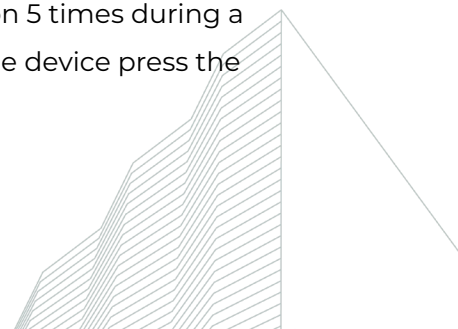

Device info

Recommended operating temperature: 0 °C ... +40 °C

Operating humidity: 8 % ... 90 % RH non-condensing

Storage temperature: 0°C ... +25 °C

Storage humidity: 5 % ... 95 % RH non-condensing

IP rating grade: IP40

Indoor office use only

Certifications: CE, FCC, ISED, RoHS, RCM, UKCA, WPC ETA-SD, KC and NOM + NYCE, IFT compliant

BT with Wirepas mesh network support

Radio sensitivity: -95 dBm BTLE

Wireless Range 5-25 m indoor, up to 100 m Line of Sight

Cellular networks

- LTE Cat M1
- GSM 850 MHz
- E-GSM 900 MHz
- DCS 1800 MHz
- PCS 1900 MHz

Micro SIM card slot

- Includes SIM card and managed SIM subscription

LED indication for device status

Power button

Micro USB powered

Maximum transmit power

| Supported radio networks | Operating frequency bands | Max. transmitted radio frequency power |
|--------------------------|-----------------------------------|--|
| LTE Cat M1 | 2, 3, 4, 5, 8, 12, 13, 20, 26, 28 | +23 dBm |
| 2G GPRS/EGPRS | 850/900 MHz | +33/27 dBm |
| 2G GPRS/EGPRS | 1800/1900 MHz | +30/26 dBm |
| Wirepas mesh | ISM 2.4 GHz | ISM 2.4 GHz |

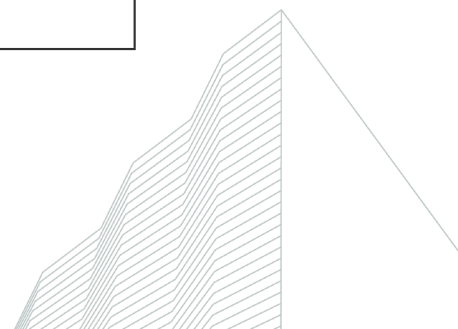

Device dimensions

Weight:
43 g (including batteries)

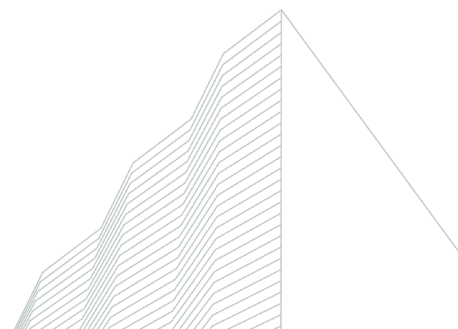
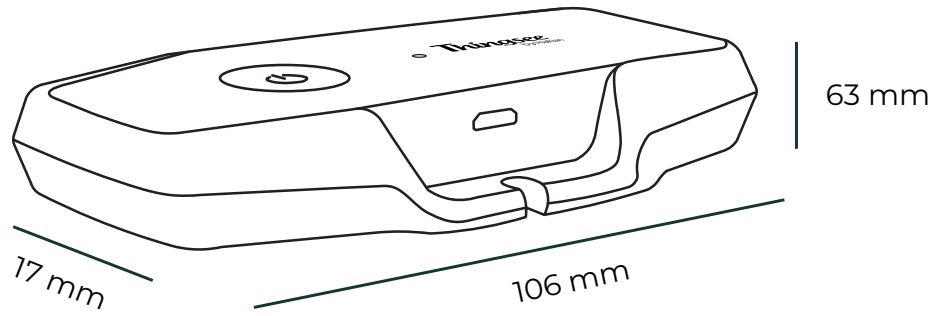

CERTIFICATION INFORMATION
EU DECLARATION OF CONFORMITY

Hereby, Haltian Oy declares that the radio equipment type Thingsee GATEWAY is in compliance with Directive 2014/53/EU. The full text of the EU declaration of conformity is available at the following internet address: support.haltian.com

Haltian Oy vakuuttaa, että radiolaitetyyppi Thingsee GATEWAY on direktiivin 2014/53/EU mukainen. EU-vaatimustenmukaisuusvakuutuksen täysimittainen teksti on saatavilla seuraavassa internetosoitteessa: support.haltian.com

Hereby, Haltian Oy declares that the radio equipment type TPR is in compliance with the UK relevant statutory requirements (Radio Equipment Regulations 2017 (SI 2017 No. 1206)). The full text of the declaration of conformity is available at the following internet address: support.haltian.com

Thingsee GATEWAY operates at Bluetooth® 2.4 GHz frequency, GSM 850/900 MHz, GSM 1800/1900 MHz bands and LTE Cat M1 2, 3, 4, 5, 8, 12, 13, 20, 26, 28 bands. Maximum radio-frequency powers transmitted are +4.0 dBm, +33.0 dBm and +30.0 dBm, respectively.

Manufacturer name and address:

Haltian Oy
Yrttipellontie 1 D
90230 Oulu
Finland

FCC REQUIREMENTS FOR OPERATION IN THE UNITED STATES

FCC Information for the User

This product does not contain any user serviceable components and is to be used with approved, internal antennas only. Any product changes or modifications will invalidate all applicable regulatory certifications and approvals.

FCC Guidelines for human Exposure

This equipment complies with FCC radiation exposure limits set forth for an uncontrolled environment. This equipment should be installed and operated with minimum distance of 20 cm between the radiator and your body. This transmitter must not be co-located or operating in conjunction with any other antenna or transmitter.

FCC Radio Frequency Interference Warnings & Instructions

This equipment has been tested and found to comply with the limits for a Class B digital device, pursuant to Part 15 of the FCC Rules. These limits are designed to provide reasonable protection against harmful interference in a residential installation. This equipment uses and can radiate radio frequency energy and, if not installed and used in accordance with the instructions, may cause harmful interference to radio communications. However, there is no guarantee that interference will not occur in a particular installation. If this equipment does cause harmful interference to radio or television reception, which can be determined by turning the equipment off and on, the user is encouraged to try to correct the interference by one or more of the following methods:

Increase the separation between the equipment and the receiver.

Connect the equipment into an electrical outlet on a circuit different from that which the radio receiver is connected

Consult the dealer or an experienced radio/TV technician for help

Any changes or modifications not expressly approved by the party responsible for compliance could void the user's authority to operate this equipment.

FCC compliance statement:

This device complies with Part 15 of the FCC Rules. Operation is subject to the following two conditions: (1) this device may not cause harmful interference, and (2) this device must accept any interference received, including interference that may cause undesired operation.

Innovation, Science and Economic Development Canada (ISED) regulatory information

This device complies with RSS-247 of the Innovation, Science and Economic Development Canada (ISED) Rules. Operation is subject to the following two conditions: (1) This device may not cause harmful interference, and (2) this device must accept any interference received, including interference that may cause undesired operation.

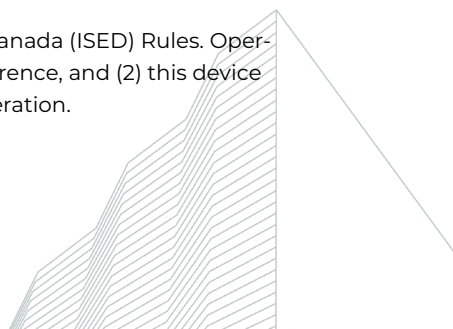

Ce dispositif est conforme à la norme CNR-247 d'Innovation, Sciences et Développement économique Canada applicable aux appareils radio exempts de licence. Son fonctionnement est sujet aux deux conditions suivantes: (1) le dispositif ne doit pas produire de brouillage préjudiciable, et (2) ce dispositif doit accepter tout brouillage reçu, y compris un brouillage susceptible de provoquer un fonctionnement indésirable.

Radiation Exposure Statement:

This device complies with ISED radiation exposure limits set forth for an uncontrolled environment. This equipment must be installed and used with a minimum distance of 20 cm between the radiator and your body.

NOTE IMPORTANTE: Déclaration d'exposition aux radiations:

Cet équipement est conforme aux limites d'exposition aux rayonnements ISED établies pour un environnement non contrôlé. Cet équipement doit être installé et utilisé avec une distance minimale de 20 cm entre le radiateur et votre corps.

FCC ID: 2AEU3TSGWGBL

IC: 20236-TSGWGBL

RCM-approved for Australia and New Zealand.

Modelo: ANATEL: 04466-24-16620

Para maiores informações, consulte o site da ANATEL www.gov.br/anatel/pt-br

Este equipamento não tem direito à proteção contra interferência prejudicial e não pode causar interferência em sistemas devidamente autorizados. Este produto não é apropriado para uso em ambientes domésticos, pois poderá causar interferências eletromagnéticas que obrigam o usuário a tomar medidas necessárias para minimizar estas interferências.

La operación de este equipo está sujeta a las siguientes dos condiciones: (1) es posible que este equipo o dispositivo no cause interferencia perjudicial y (2) este equipo o dispositivo debe aceptar cualquier interferencia, incluyendo la que pueda causar su operación no deseada.

No se recomienda el uso de este producto a una distancia menor a 20cm del cuerpo humano.

SAFETY GUIDE

Read these simple guidelines. Not following them may be dangerous or against local laws and regulations. For further information, read the user guide and visit www.haltian.com

Usage

Do not cover the device as it may prevent the device from operating properly.

Safety distance

Due to radio frequency exposure limits the gateway should be installed and operated with a minimum distance of 20 cm between the device and the body of the user or nearby persons.

Care and maintenance

Handle your device with care. The following suggestions help you keep your device operational.

Do not open, dismantle or modify the device. Unauthorized modifications may damage the device and violate regulations governing radio devices. If the device is opened by an unauthorized representative, the warranty will be null and void.

Do not store the device in wet or humid conditions.

Do not drop, knock, or shake the device. Rough handling can break it.

Only use a soft, clean, dry cloth to clean the surface of the device.

Do not clean the device with solvents, toxic chemicals or strong detergents as they may damage your device and void the warranty.

Do not paint the device. Paint can prevent proper operation.

Failure to comply with the instructions may cause damage to the device.

Damage

If the device is damaged contact support@haltian.com. Only qualified personnel may repair this device.

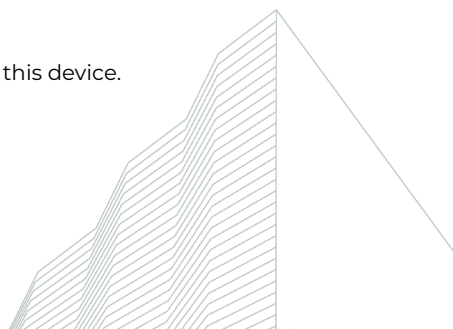

Small children

Your device is not a toy. It may contain small parts. Keep them out of the reach of small children.

Interference with medical devices

The device may emit radio waves, which could affect the operation of nearby electronics, including cardiac pacemakers, hearing aids and defibrillators. If you have a pacemaker or other implanted medical device, do not use the device without first consulting your doctor or the manufacturer of your medical device. Maintain a safe distance between the device and your medical devices and stop using the device if you observe a persistent interference with your medical device.

RECYCLING

Check the local regulations for proper disposal of electronic products. The Directive on Waste Electrical and Electronic Equipment (WEEE), which entered into force as European law on 13th February 2003, resulted in a major change in the treatment of electrical equipment at end-of-life. The purpose of this Directive is, as a first priority, the prevention of WEEE, and in addition, to promote the reuse, recycling and other forms of recovery of such wastes so as to reduce disposal.

The crossed-out wheelie-bin symbol on your product, battery, literature, or packaging reminds you that all electrical and electronic products and batteries must be taken to separate collection at the end of their working life. Do not dispose of these products as unsorted municipal waste: take them for recycling. For info on your nearest recycling point, check with your local waste authority.

| | |
|---|---|
|  | 1. Equipment name, Model name: LTE 이동통신용 무선설비의 기기(기타), MTXG |
| | 2. Registration No: R-C-2ae-MTXG |
| | 3. Applicant name: Haltian Oy |
| | 4. Manufacture date: 2024 |
| | 5. Manufacturer / Country of Origin: Haltian Oy / Finland |

| |
|---|
| Puerta de Enlace (Thingsee GATEWAY GLOBAL) |
| Marca: Thingsee |
| Modelo: MTXG |
| Alimentación: 5.0 V= 2.1 A 10.5 W max |
| Fabricante: Haltian Oy |
| Hecho en Finlandia |
| Certification number: CETHMT24-27431 |
|  |



Innovation, Science and Economic Development Canada

Innovation, Sciences et Développement économique Canada



Get to know all our Haltian devices



Thingsee
PRESENCE



Thingsee
ENVIRONMENT



Thingsee ENVIRONMENT
RUGGED



Thingsee LEAKAGE
RUGGED

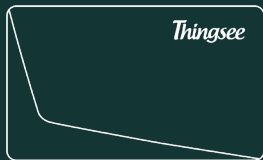

Thingsee
AIR



Thingsee
BEAM

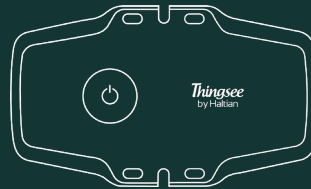

Thingsee GATEWAY
GLOBAL



Haltian
RADAR

For all devices and more information, visit our website
www.haltian.com or contact sales@haltian.com

