

Thingsee

ENVIRONMENT

Quick Guide



- 1.** Identify the sensor by reading the QR code on the front of the device.

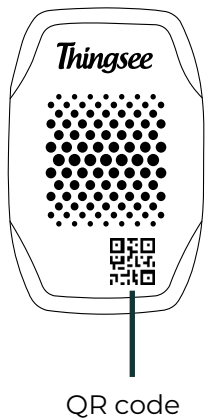

- 2.** Carefully pull out the battery security tab.

Security tab

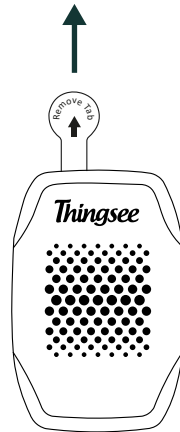

- 3.** Clean the installation surface with IPA solvent.

Surface

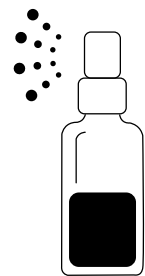

- 4.** Remove the tape's paper cover.

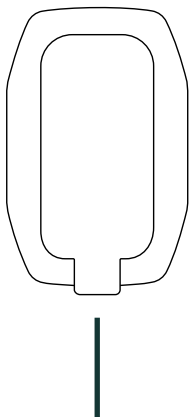

Tape with paper cover

- 5.** Install the sensor to designated location by pushing firmly against the surface for a minimum of 5 seconds.

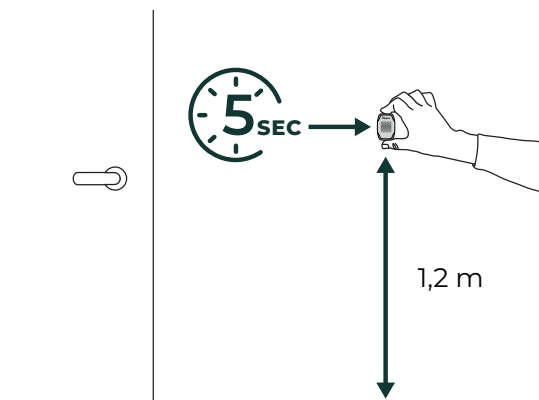

Check all the use cases from the user guide

Continue to read the detailed installation instructions.

Watch installation video here



Thingsee ENVIRONMENT

User and Installation Guide

v.24.05

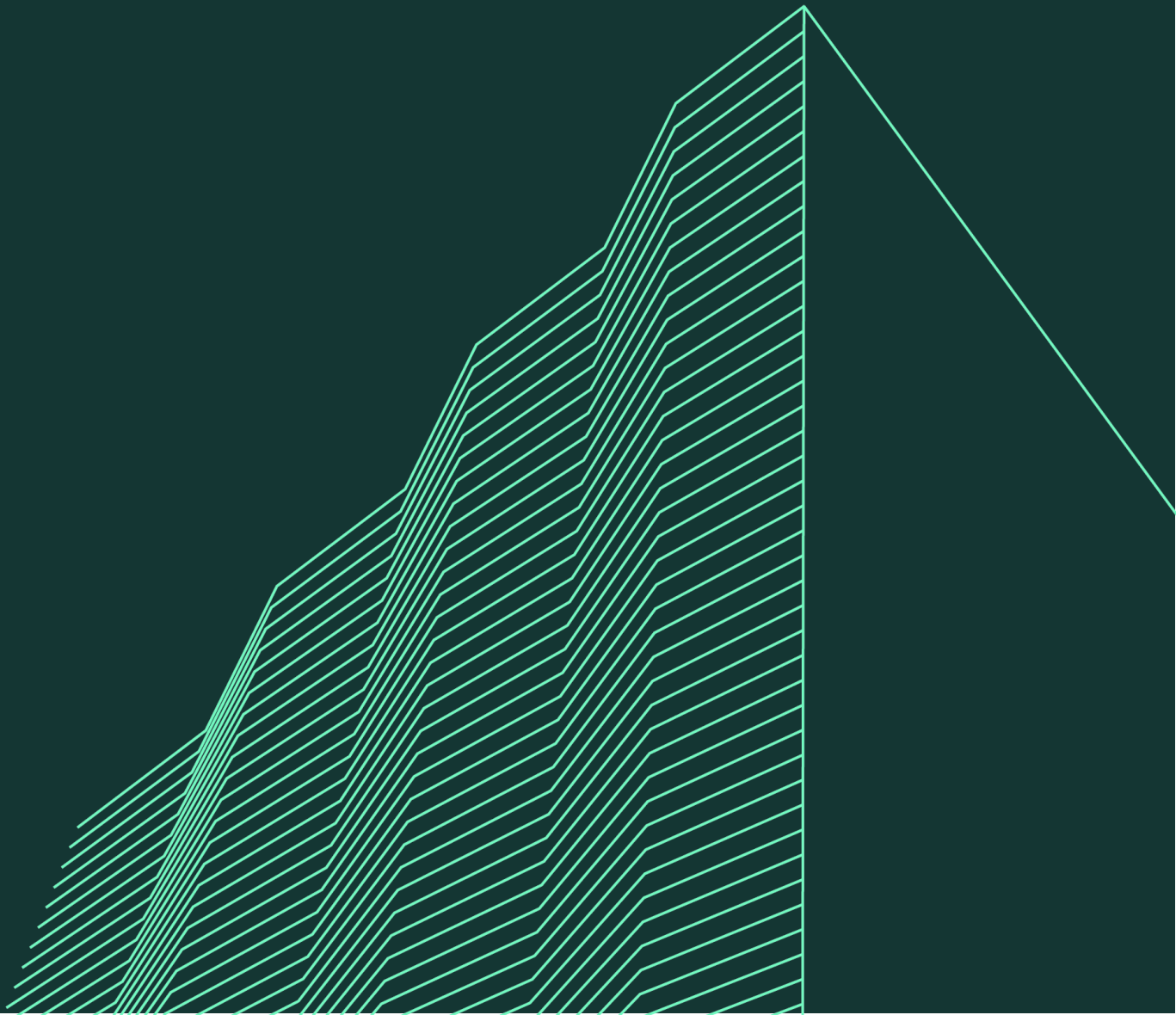

Welcome to using Haltian Thingsee

We at Haltian want to make IoT simple, so we have created a solution that is easy to use, scalable, and secure. I hope it will help you achieve your business goals!

Pasi Leipälä
CEO, Haltian Oy

Thingsee ENVIRONMENT



Thingsee ENVIRONMENT is a multipurpose wireless IoT sensor for environment monitoring. It is a perfect match for building new IoT solutions for a variety of business verticals. It can be used to measure several environmental variables or monitor machine usage rates.

Thingsee ENVIRONMENT is a part of Haltian Thingsee IoT solution and product family.

Sales package content

- Thingsee ENVIRONMENT sensors
- 1 x Opening Key
- 2 x AAA batteries (pre-installed, replaceable)

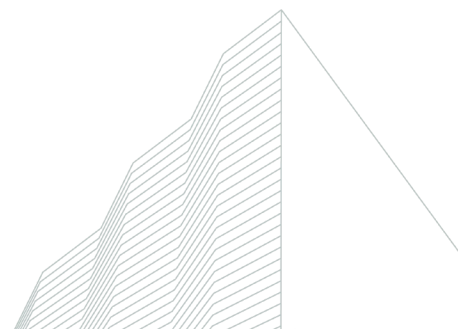

Using Thingsee ENVIRONMENT sensor

Indoor environment monitoring can make any building or space smart.

Real-time information over temperature and humidity can be used to create better end-user experiences, efficient energy consumption and better facility management planning with factual data over the environmental factors.

Thingsee ENVIRONMENT sensor measures temperature, humidity, barometric pressure, and ambient light. In addition, it has an accelerometer and a magnetic switch.

Thingsee ENVIRONMENT's magnetic switch recognition can be used to monitor the open/closed position of doors and windows, and the ambient light sensor can recognize if the lights are on or off.

The accelerometer can identify the sensor's position, but also recognise even the smallest G-forces, which can be used to measure machine usage rates. This is very handy when tracking the usage for various machines and predicting their maintenance needs.

The sensor is for indoor use only.

The environment humidity can be measured between 0 - 100 % RH at all time.

The usage temperature range is -40 °C to +85 °C, non-condensing environments only.

Note before installation

Please make sure the Thingsee gateway device is installed before you install the sensor.

To ensure strong enough signal strength for data delivery, keep the maximum distance between installed sensors under 20 m.

If the distance between a measuring sensor and the gateway is > 20 m or if the sensors are separated by a fire door or other thick building materials, use extra sensors as routers to ensure adequate signal strength.

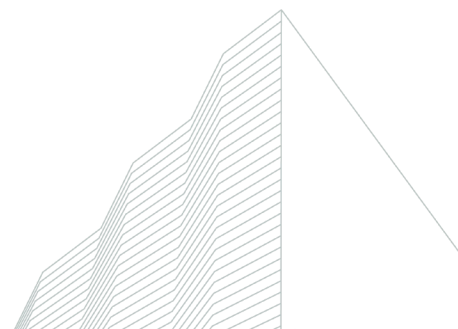

Things to avoid in installation

Avoid installing the Thingsee products near the following:

1. Thick concrete structures or thick fire doors.

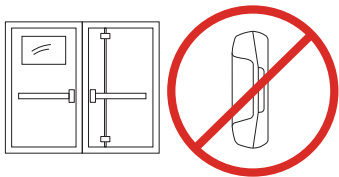

2. Electrical transformers or thick electrical wires.

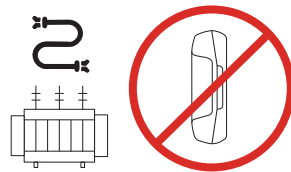

3. Escalators.



4. Nearby heating or cooling devices and/or vents.

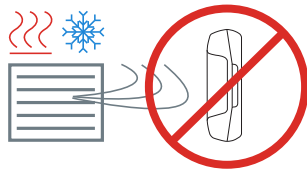

5. Direct sun light.

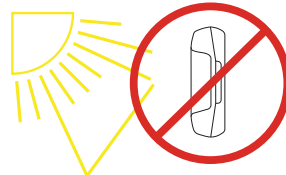

6. Nearby halogen lamps, fluorescent lamps or similar lamps with hot surface.

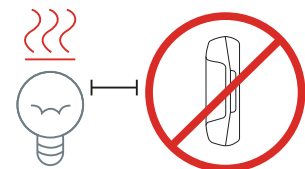

7. Nearby radio equipment like WiFi routers or any other similar high power RF transmitters.

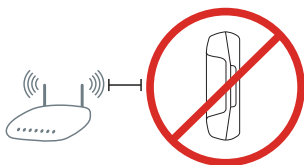

8. Inside metal box or covered with a metal plate.

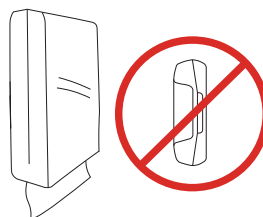

9. Inside or underneath a metal cabinet or box.



10. Near elevator motors or similar targets causing a strong magnetic field.

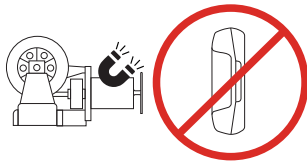

11. Avoid installing the sensor in close proximity to a spot where there's people presence constantly, such as right next to workstations.

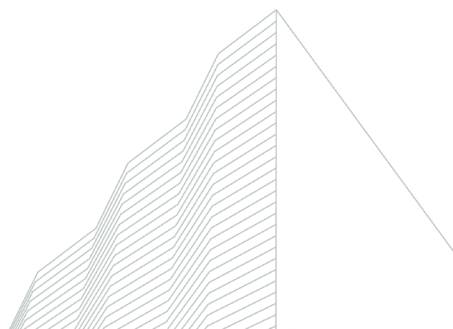

Installation

Before installing the sensors, make sure the Thingsee gateway device is installed and connected to a mobile network (LED blinking green).

To identify the sensor, read the QR code on the front of the device with a QR code reader or Thingsee Toolbox application on your mobile device.

Identifying the device is not necessary, but it will help you keep track of your IoT installation and help Haltian support to solve possible issues.

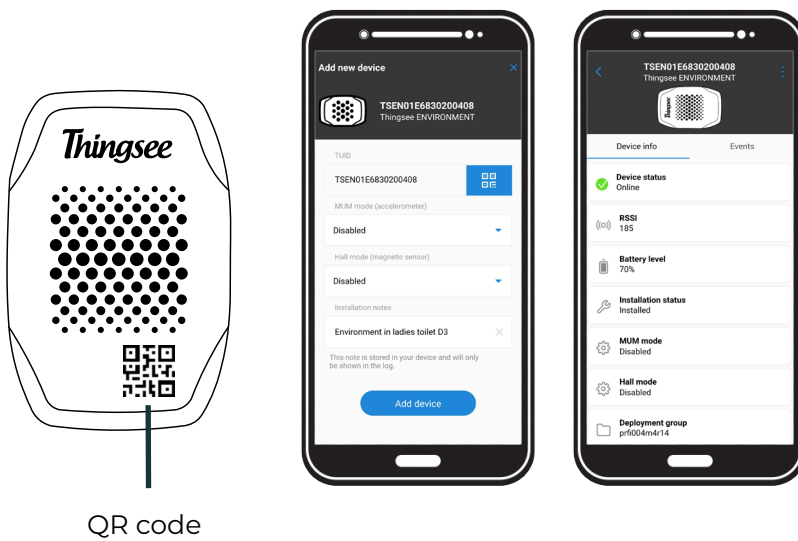

Carefully pull out the battery security tab.

LED indicator (red) will flash once. If the LED doesn't flash within 2 minutes, tap the sensor against your palm. If you do not see the LED blink or see the events from the sensor within 5 minutes, re-install the batteries.

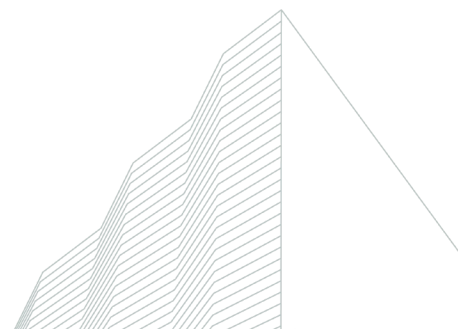
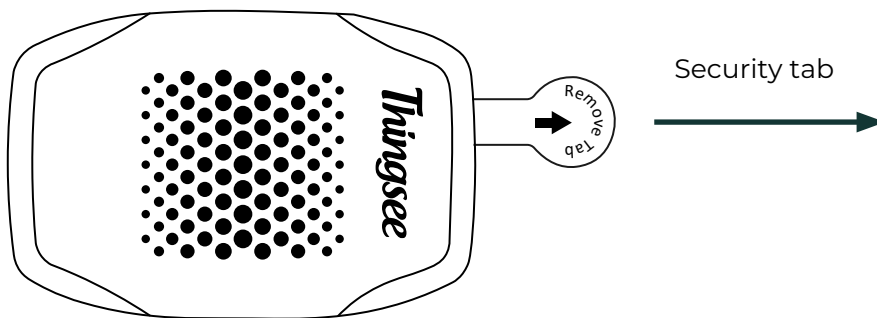

Clean the surface you will attach the sensor to with IPA -solvent (isopropyl alcohol).
Remove the tape's paper cover from the backside of the sensor.

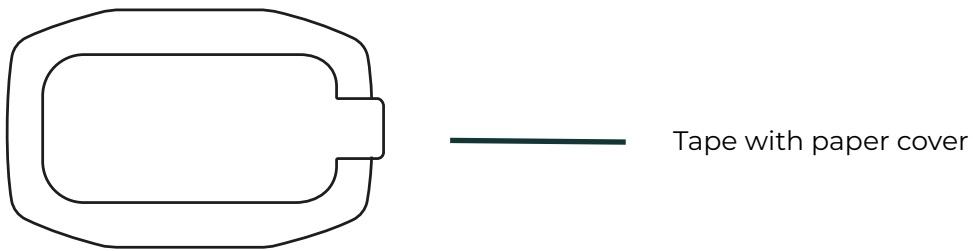

Attach the sensor to its place by pushing it firmly against the surface for a minimum of 5 seconds.

Changing the batteries

If you change the batteries, Haltian recommends using Varta Industrial Pro 1.5 V AA LR06 alkaline batteries.

Open the sensor to change the batteries or reboot the device by replacing the batteries. Use the opening key to open the sensor.



When holding the sensor in hand: Place the opening key in the hole on the side of the sensor and twist to open.

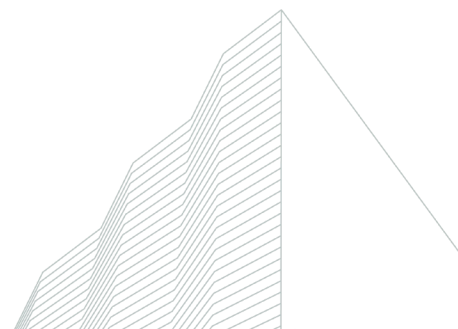
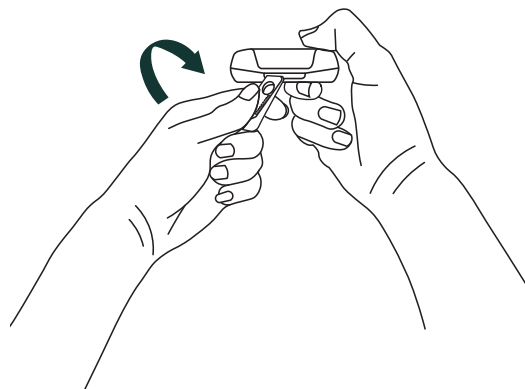

When the sensor is on the installed surface:

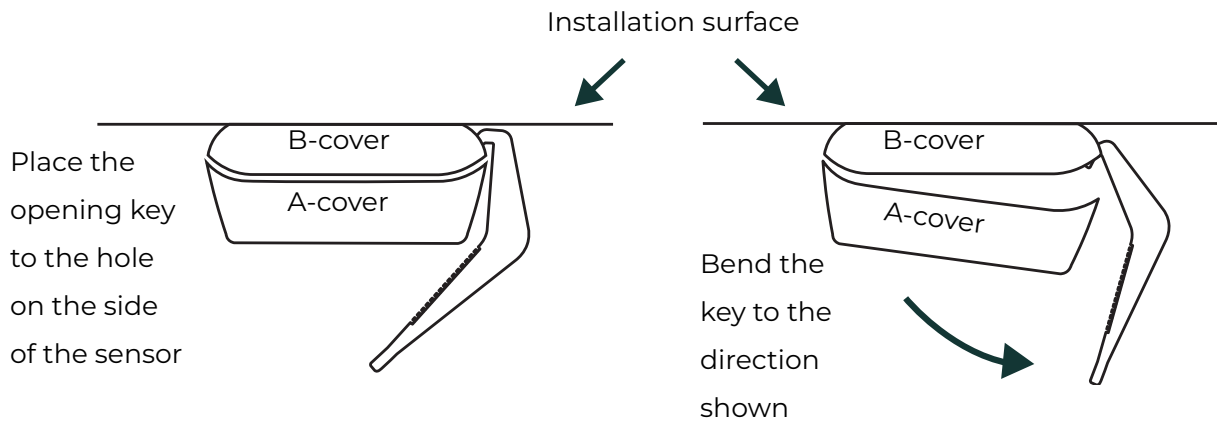

Place the batteries inside the A-cover.

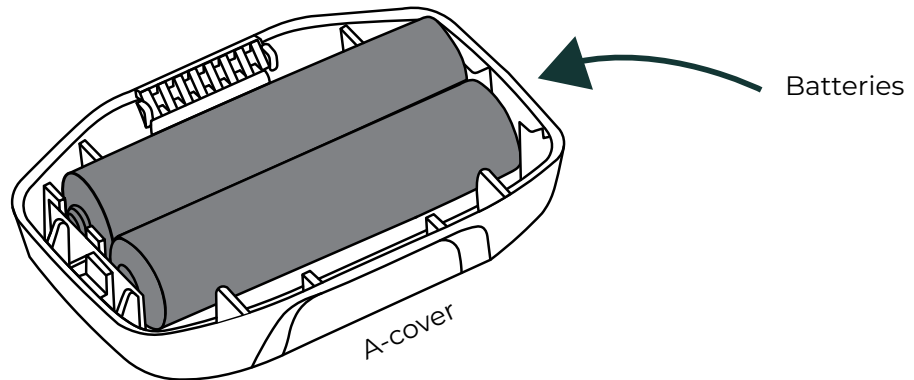

Attach the A-cover to the B-cover attached to the installed surface.

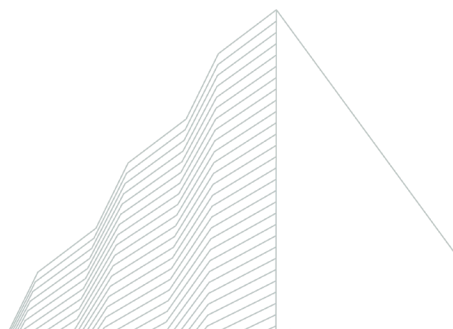
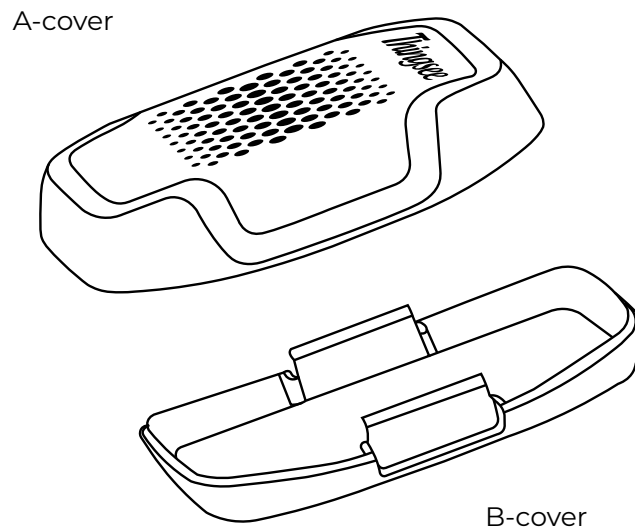

Environment monitoring

To monitor temperature, humidity, air pressure and light levels, install the sensor on a wall at 1,2 m height.

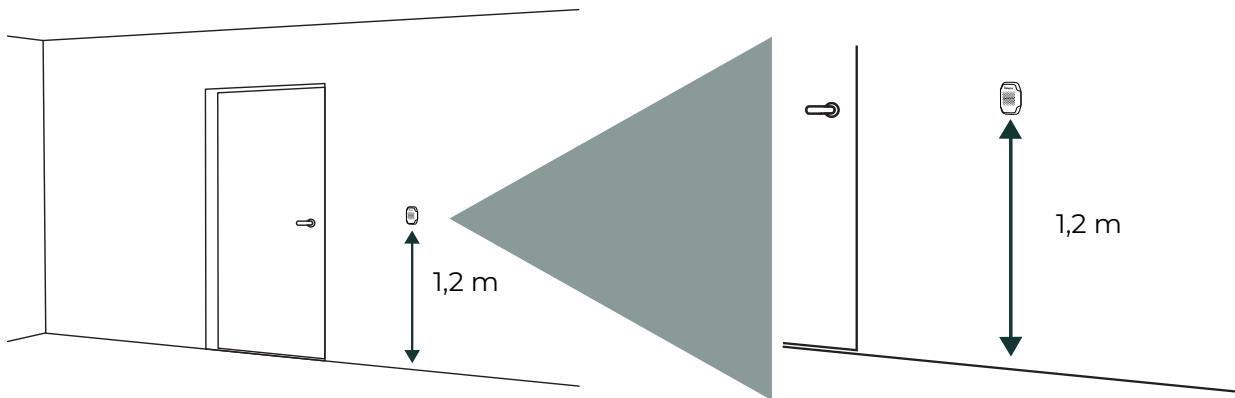

Monitoring the open/closed position of doors and windows

Thingsee ENVIRONMENT is used to monitor doors and windows with the magnet holder accessory. The magnet holder is attached to the door or window, and Thingsee ENVIRONMENT is attached to the frame, so that when the door/window is closed, the sensor detects the magnet by its side.

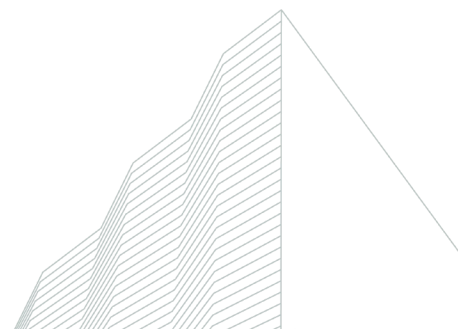
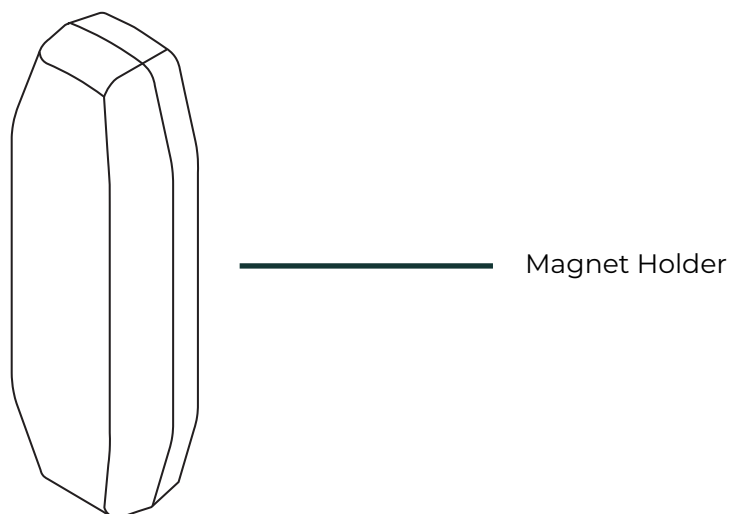

Magnet positions

The small magnet inside the magnet holder accessory is positioned so that the magnet is aligned with the magnetic switch inside Thingsee ENVIRONMENT. The magnetic switch is on the left side of the device.

When the magnet holder comes across the sensor device, the magnet is placed in magnet position 1 (see image 1). When the holder and the sensor device are aligned, the magnet is placed in magnet position 2 (see image 2). Make sure to align the sensor and the magnet holder at the bottom.

Magnet position 1

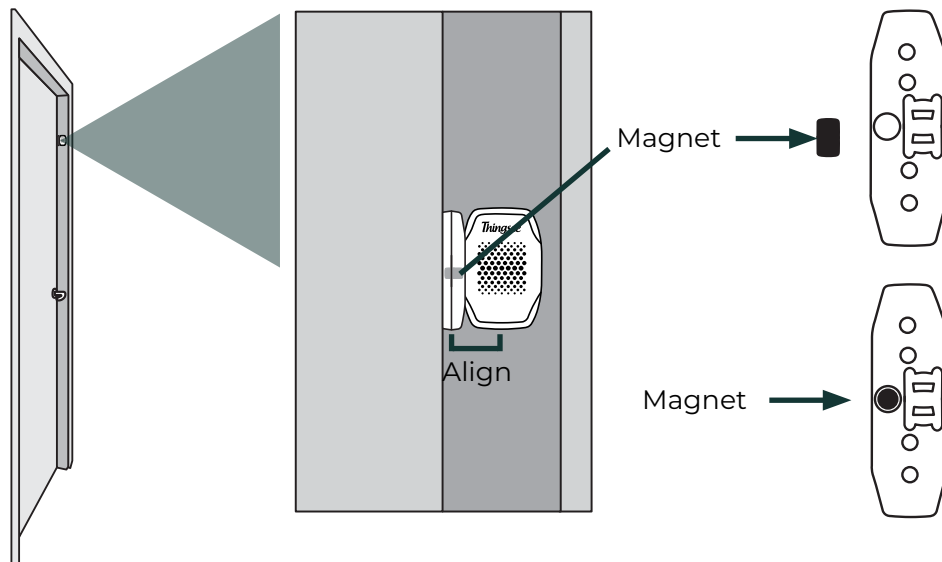

Magnet position 2

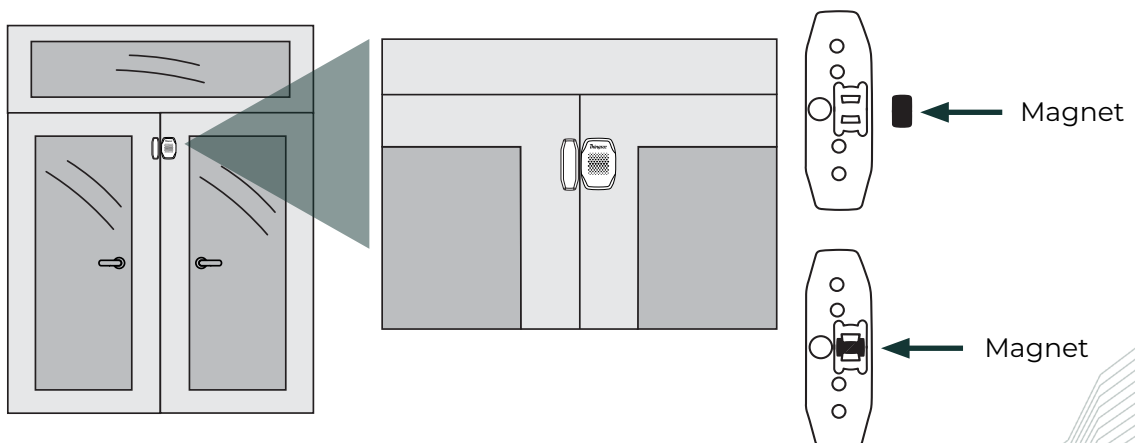

Machine usage mode

Thingsee ENVIRONMENT's accelerometer can detect the smallest of G-forces so it can be used to detect the vibration of small or big machines. The device is simply installed to where the vibration of the machine is felt when it's turned on.

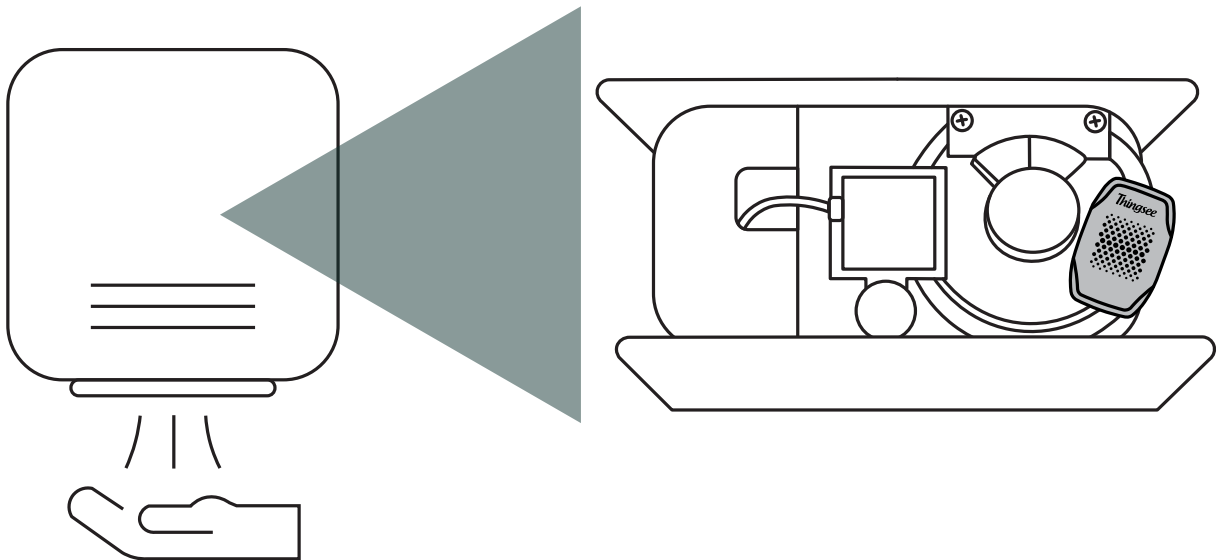

More use cases can be found at support.haltian.com

Detection capability

- Temperature -40 °C to + 85 °C. Recommended to -20° C to +50 °C due to primary battery specification. Accuracy $\pm 0,3$ °C.
- Humidity can be measured between 0 - 100 % RH. Accuracy ± 5 %.
- Accelerometer reports orientation or vibrations count in machine usage monitoring mode from 0 - 8G and 0 - 16G in high movement mode.
- Barometric pressure can be measured between 300 - 1200 hPa. Absolute accuracy is ± 1 hPa. Pressure sensor precision is ± 0.005 hPa in high precision mode.
- Ambient light sensing between 0 - 100 k lux. Light level measurement not calibrated. Only for indicative purposes.
- Magneto-resistive sensor. Detects changes in a magnetic field from magnet or high DC current.

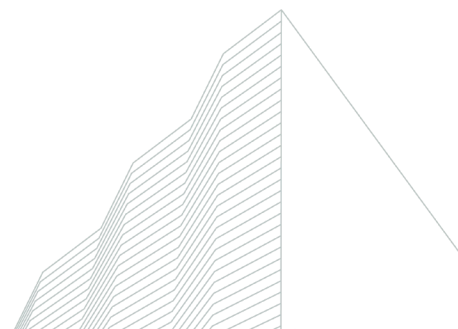

Default measurement and reporting

Event based reporting

- Measures every 5 minutes:
 - Temperature when absolute change 0,5
 - Humidity when absolute change 2
 - Ambient light when absolute change 10000
 - Air pressure when absolute change 20
 - x, y, z-axis gravity
 - Count of changes in magnetic switch

Time based reporting

- Reports all measurement values every 1 hour

Machine usage mode

- Measurement frequency: 50Hz
- Reporting interval: 1 minute - Only reports measurement periods where activity was detected
- Detected vibration range: 128mG - 8G/16G
- Battery life up to 5 years

Radio connectivity: Wirepas Mesh

Other default settings

- Battery reporting interval 6 hours

Changing the default settings

The following parameters are configurable remotely over Thingsee Operations Cloud

- Measurement interval
- Reporting interval
- Enable/disable machine-usage-monitoring mode

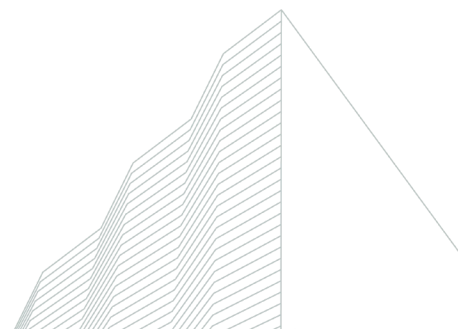

Device info

Operating temperature -20°C ... +50°C

Operating humidity 0% ... 100% RH non-condensing

Storage temperature 0°C ... +25°C

Storage humidity 45% ... 85% RH non-condensing

IP rating grade: IP30

Certifications: CE, FCC, ISED, RoHS, RCM, MIC, UKCA and NOM + NYCE, IFT compliant

Battery type: 2 x AAA, replaceable

Expected battery life:

- Up to 5 years with 5 minutes interval (default)
- Up to 4 years with 1 minute interval
- Up to 6 years with 15 minutes interval
- Up to 4 years with Machine Usage Mode

Radio sensitivity: -95 dBm (BTLE)

More device info can be found at support.haltian.com

Device dimensions

Weight:
35 g (including batteries)

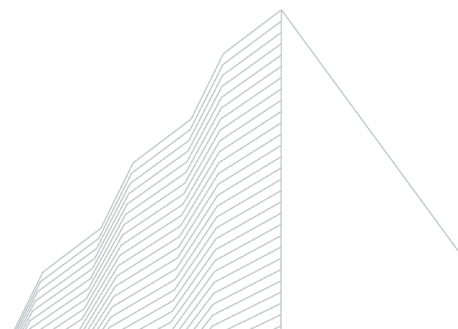
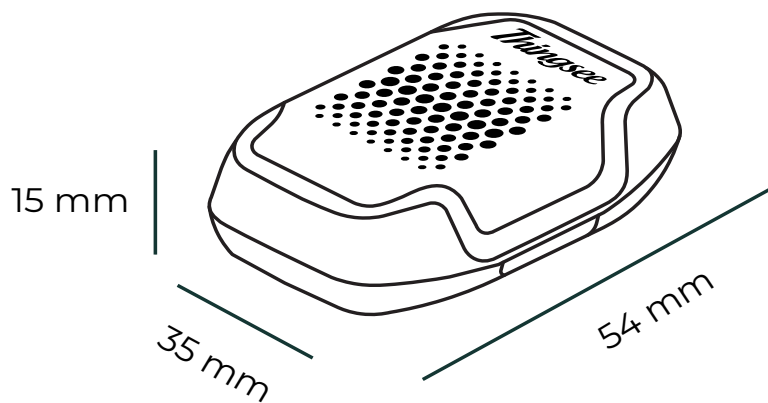

CERTIFICATION INFORMATION
EU DECLARATION OF CONFORMITY

Hereby, Haltian Oy declares that the radio equipment Thingsee AIR is in compliance with Directive 2014/53/EU. The full text of the EU declaration of conformity is available at the following internet address: support.haltian.com

Haltian Oy vakuuttaa, että radiolaitetyyppi Thingsee AIR on direktiivin 2014/53/EU mukainen. EU-vaatimustenmukaisuusvakuutuksen täysimittainen teksti on saatavilla seuraavassa internetosoitteessa:
support.haltian.com

Hereby, Haltian Oy declares that the radio equipment type PD2 is in compliance with the UK relevant statutory requirements (Radio Equipment Regulations 2017 (SI 2017 No. 1206)). The full text of the declaration of conformity is available at the following internet address: support.haltian.com

Thingsee AIR operates at Bluetooth® 2.4 GHz frequency band. Maximum radio-frequency power transmitted is +4.0 dBm.

Manufacturer name and address:

Haltian Oy
Yrttipellontie 1 D
90230 Oulu
Finland

FCC REQUIREMENTS FOR OPERATION IN THE UNITED STATES

FCC Information for the User

This product does not contain any user serviceable components and is to be used with approved, internal antennas only. Any product changes or modifications will invalidate all applicable regulatory certifications and approvals.

FCC Guidelines for human Exposure

This equipment complies with FCC radiation exposure limits set forth for an uncontrolled environment. This equipment should be installed and operated with minimum distance of 20 cm between the radiator and your body. This transmitter must not be co-located or operating in conjunction with any other antenna or transmitter.

FCC Radio Frequency Interference Warnings & Instructions

This equipment has been tested and found to comply with the limits for a Class B digital device, pursuant to Part 15 of the FCC Rules. These limits are designed to provide reasonable protection against harmful interference in a residential installation. This equipment uses and can radiate radio frequency energy and, if not installed and used in accordance with the instructions, may cause harmful interference to radio communications. However, there is no guarantee that interference will not occur in a particular installation. If this equipment does cause harmful interference to radio or television reception, which can be determined by turning the equipment off and on, the user is encouraged to try to correct the interference by one or more of the following methods:

Increase the separation between the equipment and the receiver.

Connect the equipment into an electrical outlet on a circuit different from that which the radio receiver is connected

Consult the dealer or an experienced radio/TV technician for help

Any changes or modifications not expressly approved by the party responsible for compliance could void the user's authority to operate this equipment.

FCC compliance statement:

This device complies with Part 15 of the FCC Rules. Operation is subject to the following two conditions: (1) this device may not cause harmful interference, and (2) this device must accept any interference received, including interference that may cause undesired operation.

Innovation, Science and Economic Development Canada (ISED) regulatory information

This device complies with RSS-247 of the Innovation, Science and Economic Development Canada (ISED) Rules. Operation is subject to the following two conditions: (1) This device may not cause harmful interference, and (2) this device must accept any interference received, including interference that may cause undesired operation.

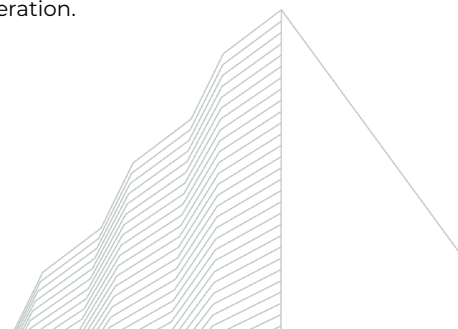

Ce dispositif est conforme à la norme CNR-247 d'Innovation, Sciences et Développement économique Canada applicable aux appareils radio exempts de licence. Son fonctionnement est sujet aux deux conditions suivantes: (1) le dispositif ne doit pas produire de brouillage préjudiciable, et (2) ce dispositif doit accepter tout brouillage reçu, y compris un brouillage susceptible de provoquer un fonctionnement indésirable

Radiation Exposure Statement :

This device complies with ISED radiation exposure limits set forth for an uncontrolled environment. This equipment must be installed and used with a minimum distance of 20 cm between the radiator and your body.

NOTE IMPORTANTE: Déclaration d'exposition aux radiations:

Cet équipement est conforme aux limites d'exposition aux rayonnements ISED établies pour un environnement non contrôlé. Cet équipement doit être installé et utilisé avec une distance minimale de 20 cm entre le radiateur et votre corps.

ISED: 20236-TSENV

FCC: 2AEU3TSENV

RCM-approved for Australia and New Zealand.

Modelo: ANATEL: 04470-24-16620

Para maiores informações, consulte o site da ANATEL www.gov.br/anatel/pt-br

Este equipamento não tem direito à proteção contra interferência prejudicial e não pode causar interferência em sistemas devidamente autorizados. Este produto não é apropriado para uso em ambientes domésticos, pois poderá causar interferências eletromagnéticas que obrigam o usuário a tomar medidas necessárias para minimizar estas interferências.

La operación de este equipo está sujeta a las siguientes dos condiciones: (1) es posible que este equipo o dispositivo no cause interferencia perjudicial y (2) este equipo o dispositivo debe aceptar cualquier interferencia, incluyendo la que pueda causar su operación no deseada.

No se recomienda el uso de este producto a una distancia menor a 20cm del cuerpo humano.

SAFETY GUIDE

Read these simple guidelines. Not following them may be dangerous or against local laws and regulations. For further information, read the user guide and visit www.haltian.com

Usage

Do not cover the device as it prevents the device from operating properly.

- This product is intended for indoor use only and shall not be exposed to rain.
- Do not modify the device. Unauthorized modifications may damage the device and violate regulations governing radio devices.
- Do not store the device in wet or humid conditions.
- Remove the batteries from the device if you are taking it inside an aeroplane (unless you have the pre-installed pull-out tape still in place). The device has a Bluetooth LE receiver/transmitter which must not be operational during a flight.
- Please take care that the used batteries are recycled by taking them to appropriate collection point.
- When changing batteries, replace both of them at the same time using identical brand and type.
- Do not swallow batteries.
- Do not throw batteries into water or fire.
- Do not short-circuit batteries.
- Do not try to charge primary batteries.
- Do not open or disassemble batteries.
- Batteries should be stored in a dry place and at room temperature. Avoid large temperature changes and direct sunlight.

At higher temperature the electrical performance of the batteries may be reduced.

- Keep batteries away from children.

Care and maintenance

Handle your device with care. The following suggestions help you keep your device operational.

- Do not open the device other than as instructed in the user guide.

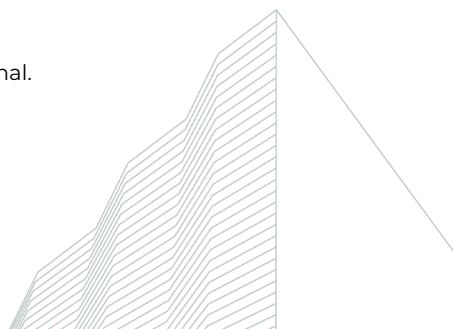

- Unauthorized modifications may damage the device and violate regulations governing radio devices.
- Do not drop, knock, or shake the device. Rough handling can break it.
- Only use a soft, clean, dry cloth to clean the surface of the device. Do not clean the device with solvents, toxic chemicals or strong detergents as they may damage your device and void the warranty.
- Do not paint the device. Paint can prevent proper operation.

Damage

If the device is damaged contact support@haltian.com. Only qualified personnel may repair this device.

Small children

Your device is not a toy. It may contain small parts. Keep them out of the reach of small children.

RECYCLING

Check the local regulations for proper disposal of electronic products. The Directive on Waste Electrical and Electronic Equipment (WEEE), which entered into force as European law on 13th February 2003, resulted in a major change in the treatment of electrical equipment at end-of-life. The purpose of this Directive is, as a first priority, the prevention of WEEE, and in addition, to promote the reuse, recycling and other forms of recovery of such wastes so as to reduce disposal.

The crossed-out wheelie-bin symbol on your product, battery, literature, or packaging reminds you that all electrical and electronic products and batteries must be taken to separate collection at the end of their working life. Do not dispose of these products as unsorted municipal waste: take them for recycling. For info on your nearest recycling point, check with your local waste authority.

Care and maintenance

Handle your device with care. The following suggestions help you keep your device operational.

- Do not open the device other than as instructed in the user guide.
- Unauthorized modifications may damage the device and violate regulations governing radio devices.
- Do not drop, knock, or shake the device. Rough handling can break it.
- Only use a soft, clean, dry cloth to clean the surface of the device. Do not clean the device with solvents, toxic chemicals or strong detergents as they may damage your device and void the warranty.
- Do not paint the device. Paint can prevent proper operation.

Damage

If the device is damaged contact support@haltian.com. Only qualified personnel may repair this device.



Small children

Your device is not a toy. It may contain small parts. Keep them out of the reach of small children.

RECYCLING

Check the local regulations for proper disposal of electronic products. The Directive on Waste Electrical and Electronic Equipment (WEEE), which entered into force as European law on 13th February 2003, resulted in a major change in the treatment of electrical equipment at end-of-life. The purpose of this Directive is, as a first priority, the prevention of WEEE, and in addition, to promote the reuse, recycling and other forms of recovery of such wastes so as to reduce disposal.

The crossed-out wheelie-bin symbol on your product, battery, literature, or packaging reminds you that all electrical and electronic products and batteries must be taken to separate collection at the end of their working life. Do not dispose of these products as unsorted municipal waste: take them for recycling. For info on your nearest recycling point, check with your local waste authority.

Sensor Ambiental (Thingsee ENVIRONMENT)	
Marca: Thingsee	
Modelo: PD2	
Fabricante: Haltian Oy	
2 pilas alcalinas AAA	
Hecho en Finlandia	
Certification number: CETHPD24-27103	
	



Innovation, Science and
Economic Development Canada

Innovation, Sciences et
Développement économique Canada



Get to know all our Haltian devices



Thingsee
PRESENCE



Thingsee
ENVIRONMENT



Thingsee ENVIRONMENT
RUGGED



Thingsee LEAKAGE
RUGGED



Thingsee
AIR



Thingsee
BEAM

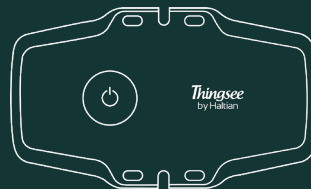

Thingsee GATEWAY
GLOBAL



Haltian
RADAR

For all devices and more information, visit our website
www.haltian.com or contact sales@haltian.com

