

# Thingsee

## AIR

### Quick Guide



#### 1. Opening the device

a) When holding the sensor in hand: Place the opening key in the hole on the side of the sensor and twist to open.

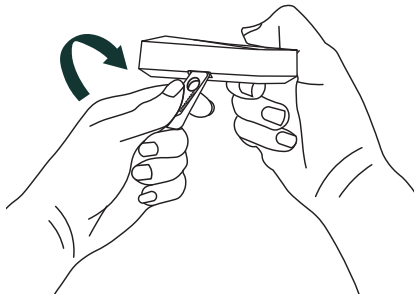

b) When the sensor is on the wall: Bend the key to the direction shown.

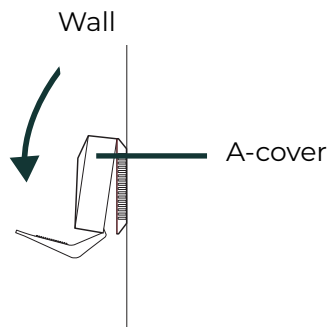

2. Take the B-cover and install it to the wall with a screw or tapes. The recommended height is between 1,4 m – 1,8 m.

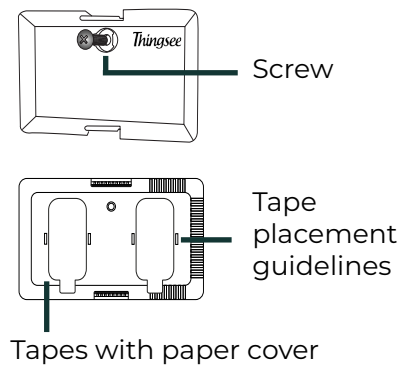

3. Place the batteries inside the A-cover.

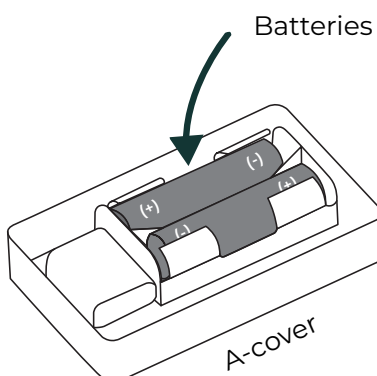

4. Identify the sensor by reading the QR code on the side of the A-cover.

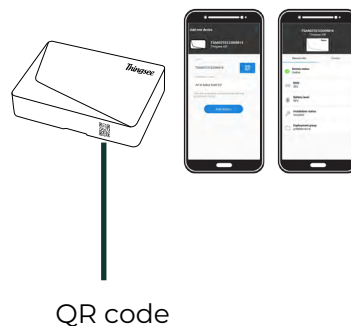

5. Attach the A-cover to the B-cover attached to the wall. (Make sure the Thingsee logo is the right way).

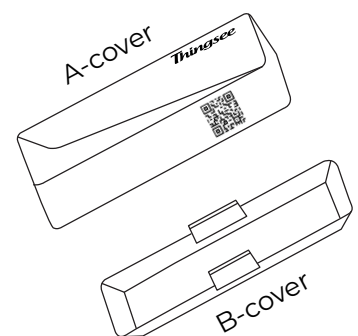

Continue to read the detailed installation instructions.

Watch installation video here



# *Thingsee* AIR

## User and Installation Guide

v.24.06

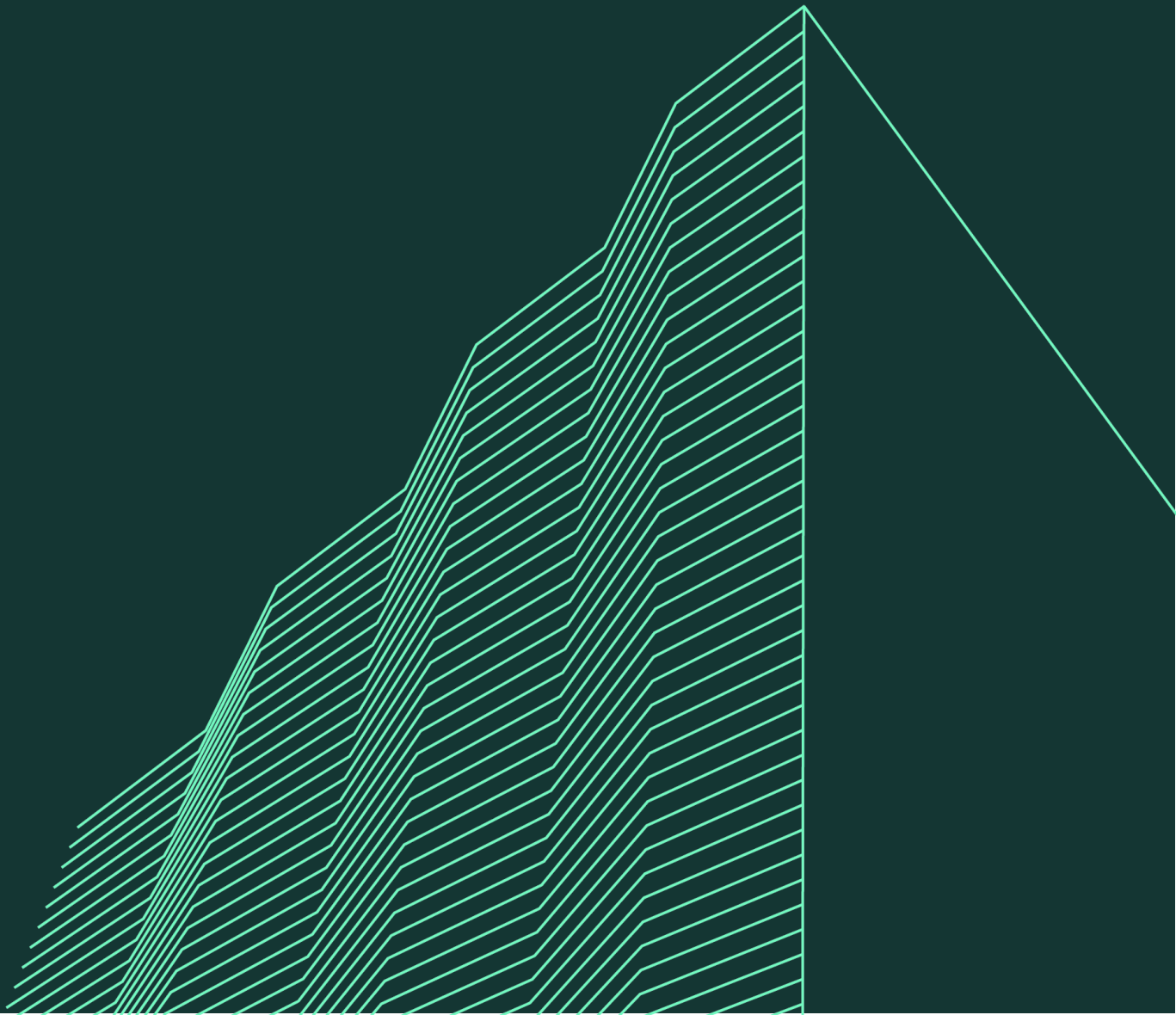

# Welcome to using Haltian Thingsee

We at Haltian want to make IoT simple, so we have created a solution that is easy to use, scalable, and secure. I hope it will help you achieve your business goals!

Pasi Leipälä  
CEO, Haltian Oy

## Thingsee AIR



Thingsee AIR is a state of the art, battery powered wireless IoT sensor for your indoor air quality monitoring. Together with CO<sub>2</sub>, TVOC, temperature, barometric pressure and humidity sensors, it's a perfect device to provide an extensive overlook to both present air quality data and the data history.

Thingsee AIR is a part of Haltian Thingsee IoT solution and product family.

## Sales package content

- Thingsee AIR sensor
- 2 x AA batteries (not installed, replaceable)
- 1 x tape attachment
- 1 x Opening Key

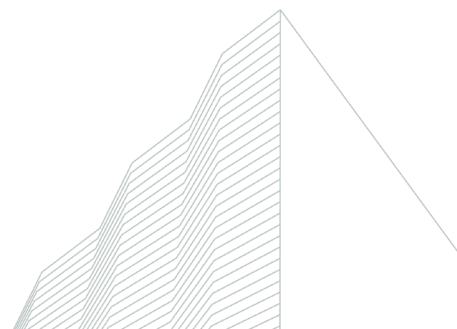

# Using Thingsee AIR sensor

Thingsee AIR detects carbon dioxide (CO<sub>2</sub>), total volatility of organic compounds (TVOC), temperature, humidity and barometric pressure. The product is installed on the wall in the space where air quality is measured.

Thingsee AIR is a perfect tool to measure indoor air quality (IAQ) in buildings and structures, especially as it relates to the health and comfort of the building's occupants. The sensor ensures real-time air quality data for, e.g. adequate ventilation in the premises.

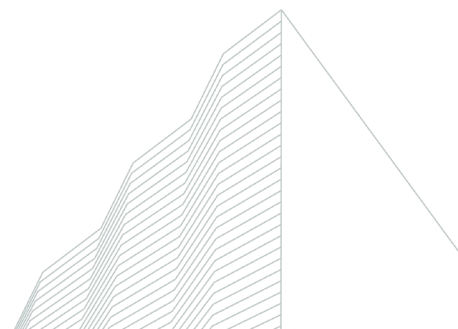
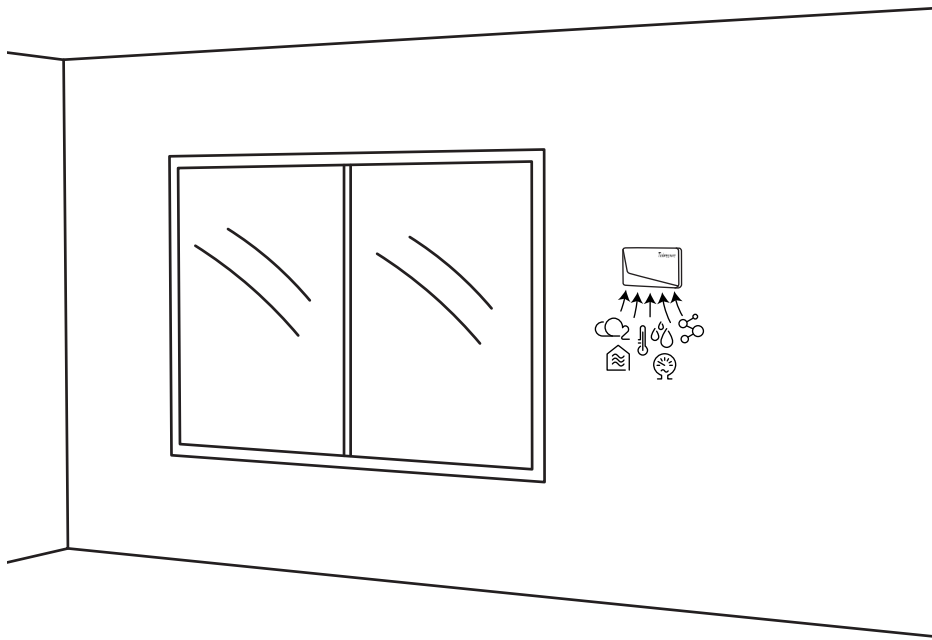

# General installation instructions

The sensor is for indoor use only.

The environment humidity should be <85 % RH at all times.

The usage temperature range is +5 °C to +50 °C, non-condensing environments only.

Please note that the correct TVOC and CO<sub>2</sub> data are available only after the sensor device has conducted baseline calibration for the environment.

TVOC sensor conducts baseline calibration for the TVOC levels and valid data is available after 48h of continuous use.

The CO<sub>2</sub> baseline optimization is always on and updated in 8 day periods. The baseline adjustment happens in steps toward the preconfigured 410ppm CO<sub>2</sub> level.

**Note:** Thingsee AIR requires 'free of people' moments in the space, when the indoor air is fully changed, to set the correct 410 ppm baseline. This is why places such as schools and offices are good places to use the sensor, as the baseline can be set during the night when the CO<sub>2</sub> level is the lowest.

## Note before installation

Please make sure the Thingsee GATEWAY is installed before you install the sensor.

To ensure strong enough signal strength for data communication, keep the maximum distance between installed sensors under 20 m.

If the distance between a measuring sensor and the gateway is > 20 m or if the sensors are separated by a fire door or other thick building materials, use extra sensors as routers to ensure adequate signal strength.

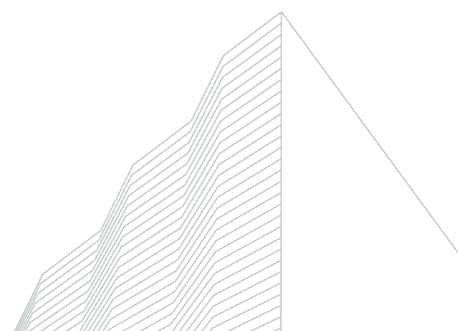

# Things to avoid in installation

The following can effect the wireless radio communication:

1. Thick concrete structures or thick fire doors

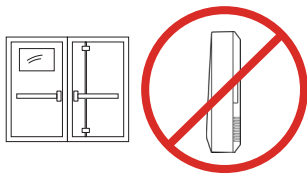

2. Electrical transformers or thick electrical wires

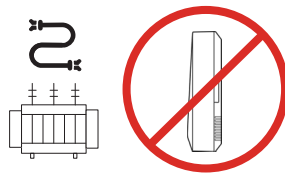

3. Escalators

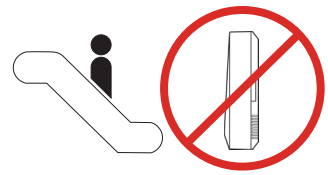

4. Nearby radio equipment like WiFi routers or any other similar high power RF transmitters

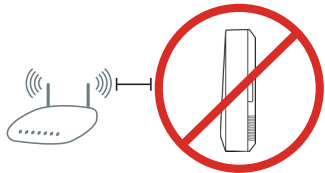

5. Nearby heating or cooling devices and/or vents



6. Close proximity to a spot where there's people presence constantly, such as right next to workstations.\*

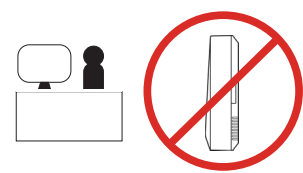

7. TVOC sources/chemical substances storage or equivalent (hand disinfectants/sanitizer etc.)

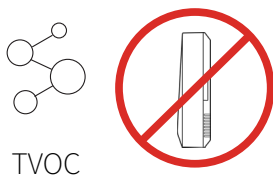

8. Direct sun light or nearby halogen lamps, fluorescent lamps or similar lamps with hot surface.

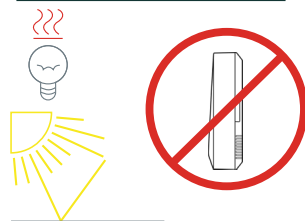

**\* Note:** because the sensor would only measure the air coming from the vents or people breathing, not the surrounding air.

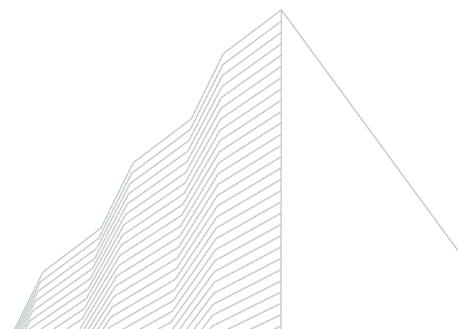

# Choosing the installation spot

Here are some example cases on where to install Thingsee AIR.

The green lines are the recommended installation spots and the red ones is where to avoid the installation of the sensor.

## If there is an air conditioner (cooling) in the room

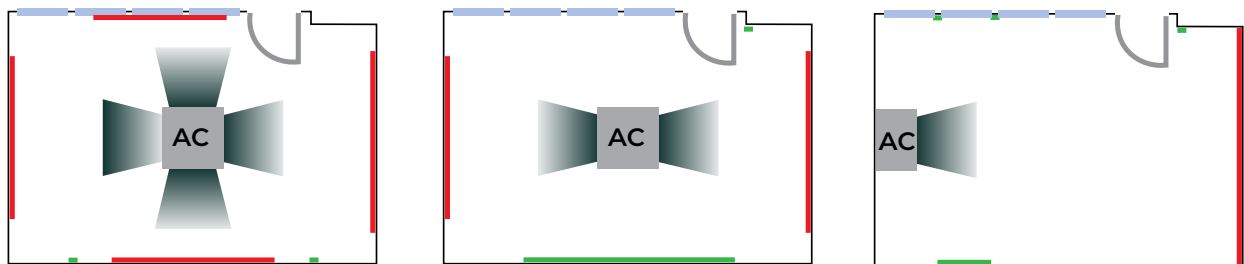

## Avoid corners

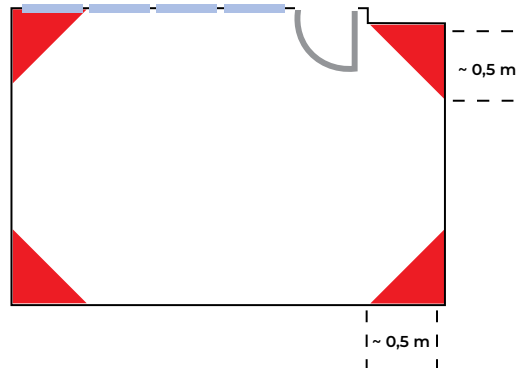

## Sun effect - large windows

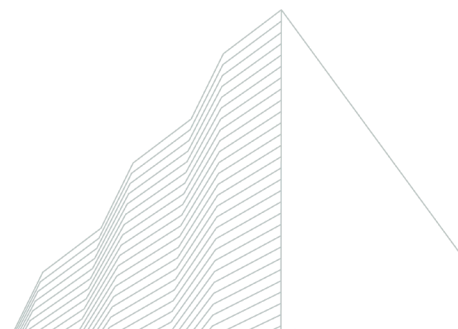
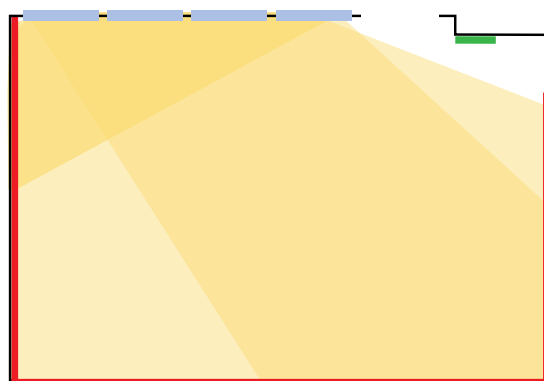

## Heating radiator

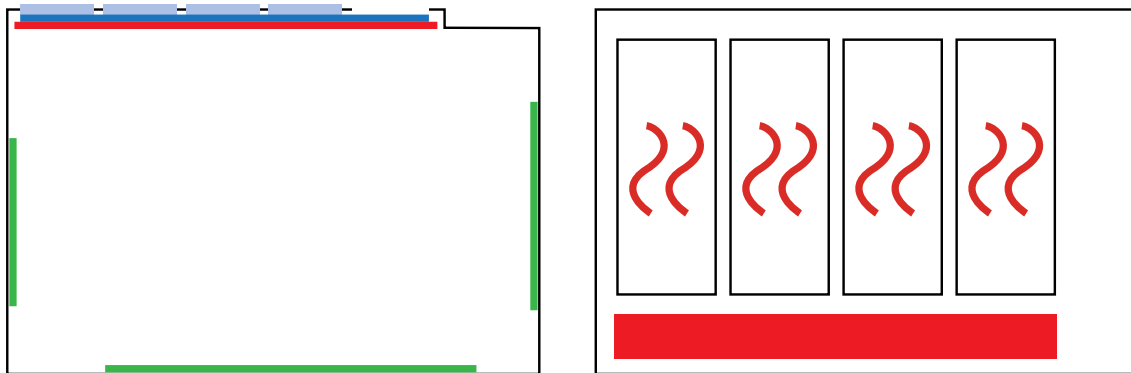

## Large, open space offices

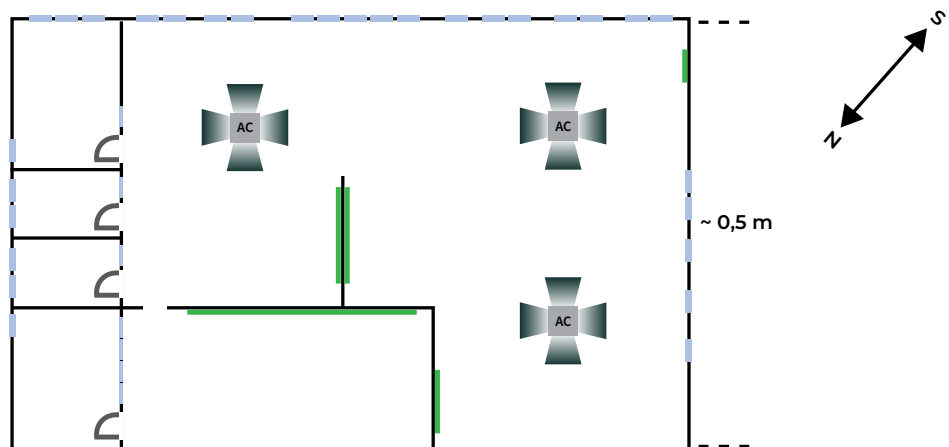

## Air ventilation, generally

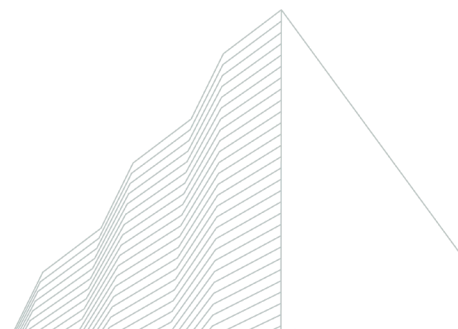
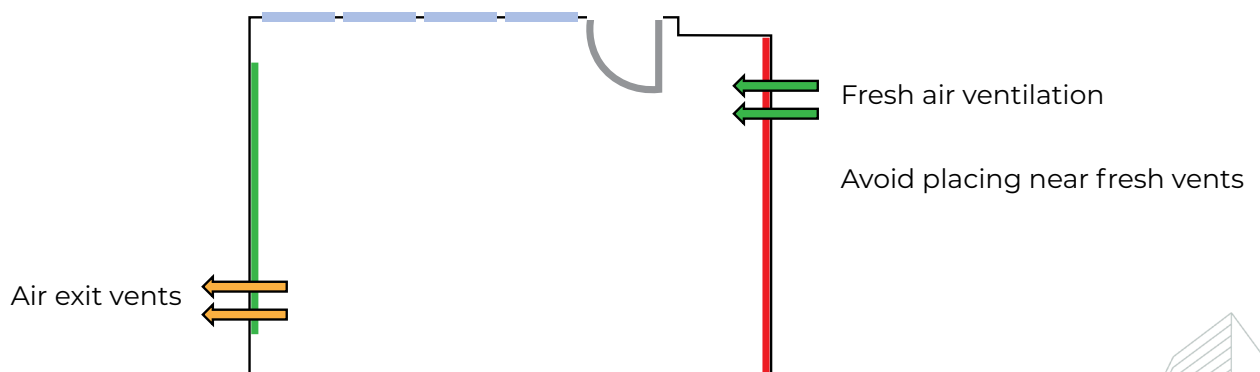



# Installation

Before installing the sensors, make sure the Thingsee gateway device is installed and connected to a mobile network (LED blinking green).

To identify the sensor, read the QR code on the side of the A-cover with a QR code reader or Thingsee Toolbox application on your mobile device.

Identifying the device is not necessary, but it will help you keep track of your IoT installation and help Haltian support to solve possible issues.



Open the box and follow the instructions of this user and installation guide. Take the product from the box and open it with the opening key.

Select a place where to install Thingsee AIR (see 'Things to avoid in the installation' before). The recommended height on the wall is between 1,4 m – 1,8 m.

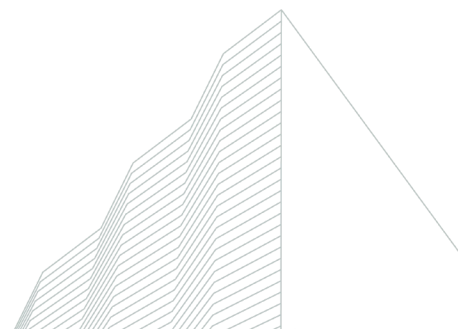
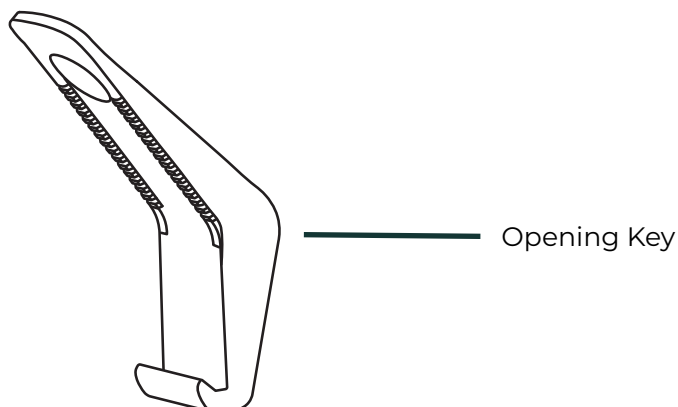

When holding the sensor in hand: Place the opening key in the hole on the side of the sensor and twist to open.

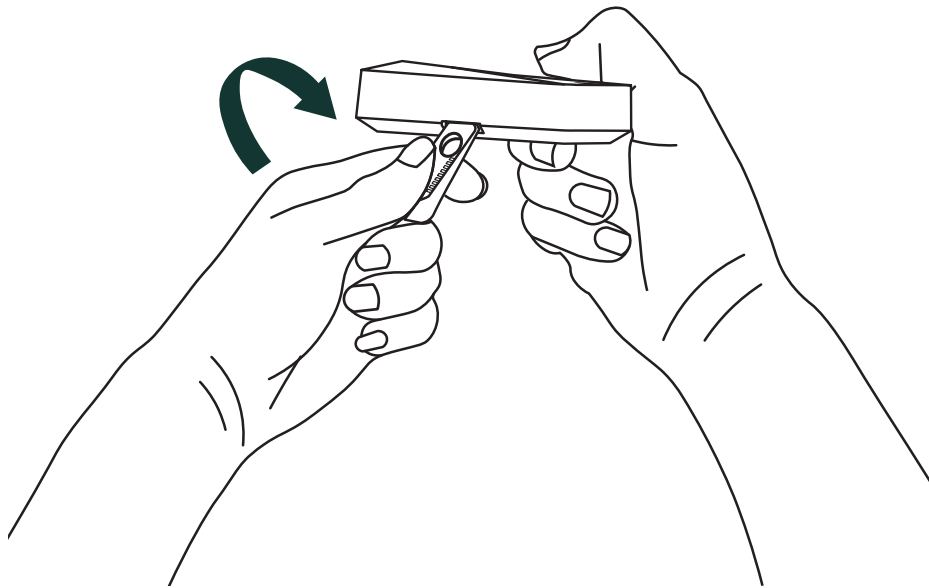

When the sensor is on the installed surface:

Place the opening key to the hole on the side of the sensor.

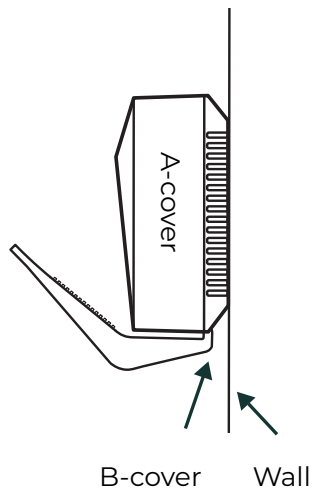

Bend the key to the direction shown.

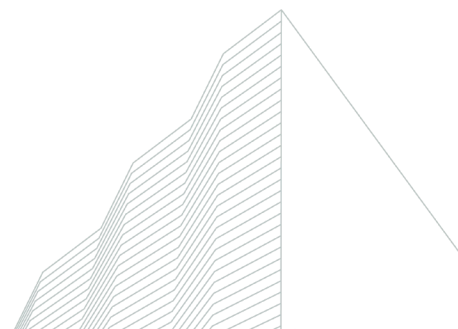
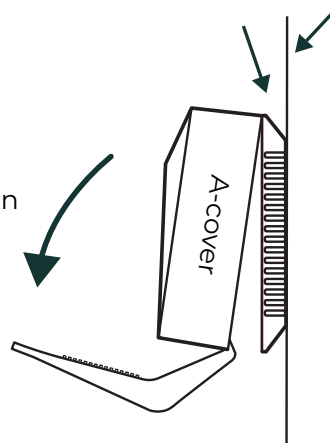

Place the batteries inside the A-cover.

If you change the batteries, Haltian recommends using Varta Industrial Pro 1.5 V AA LR06 alkaline batteries.

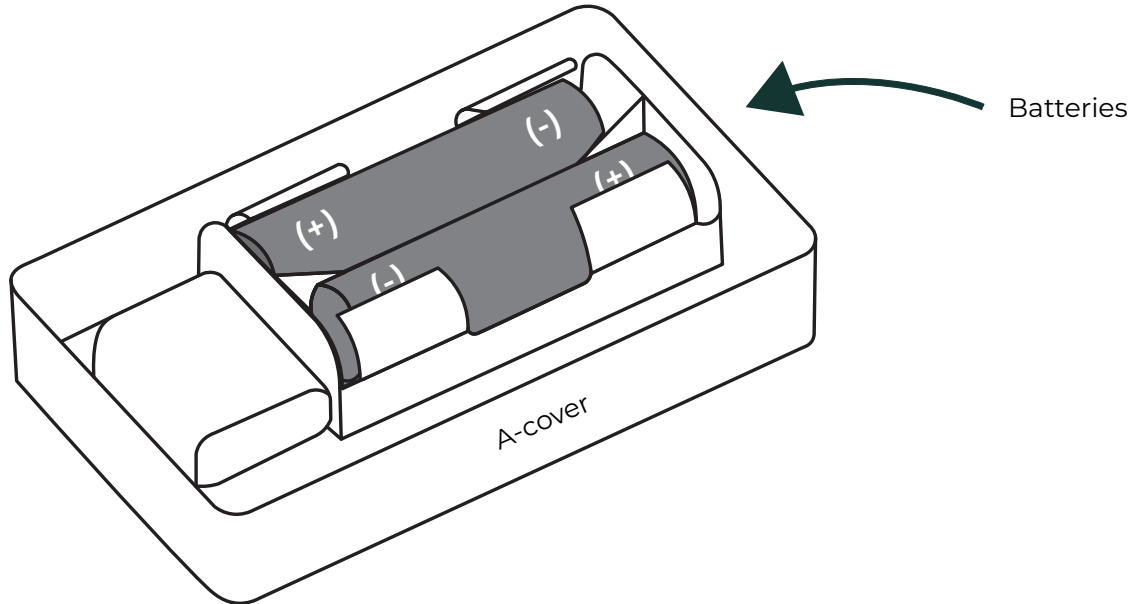

Attach the A-cover to the B-cover attached to the wall. (Make sure the Thingsee logo is the right way).

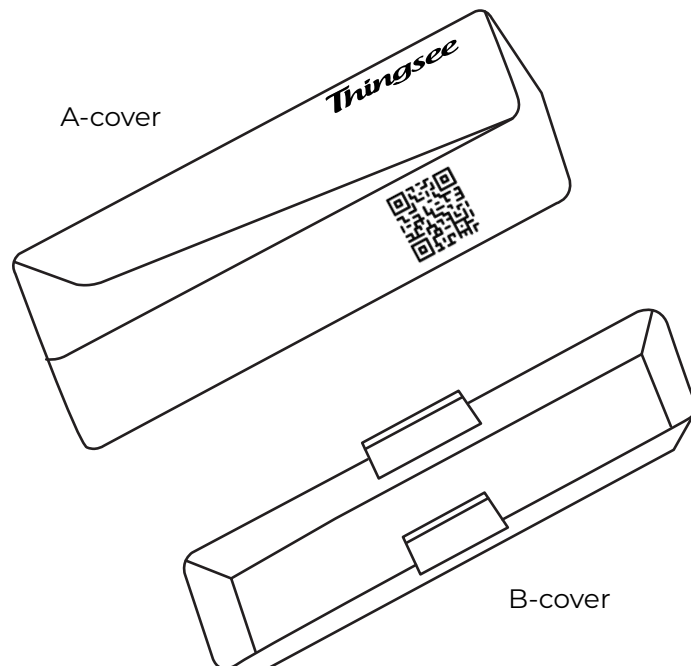

**Note:** Make sure the sensor is installed max. 20 meters from the next sensor or gateway.



# Installation method 1

## Installing Thingsee AIR with tapes

When installing Thingsee AIR using tapes, use a smooth surface for better adherence. Clean the surface you will attach the sensor to with IPA -solvent (isopropyl alcohol). Make sure that the surface of the device is clean.

The marks in the back of the sensor work as guidelines for where to place the tapes. Apply the tapes in the device and press for a minimum of 5 seconds and then remove the tapes' paper cover.

Always use the tapes provided in the sales package as other tapes or glue may affect the TVOC values.

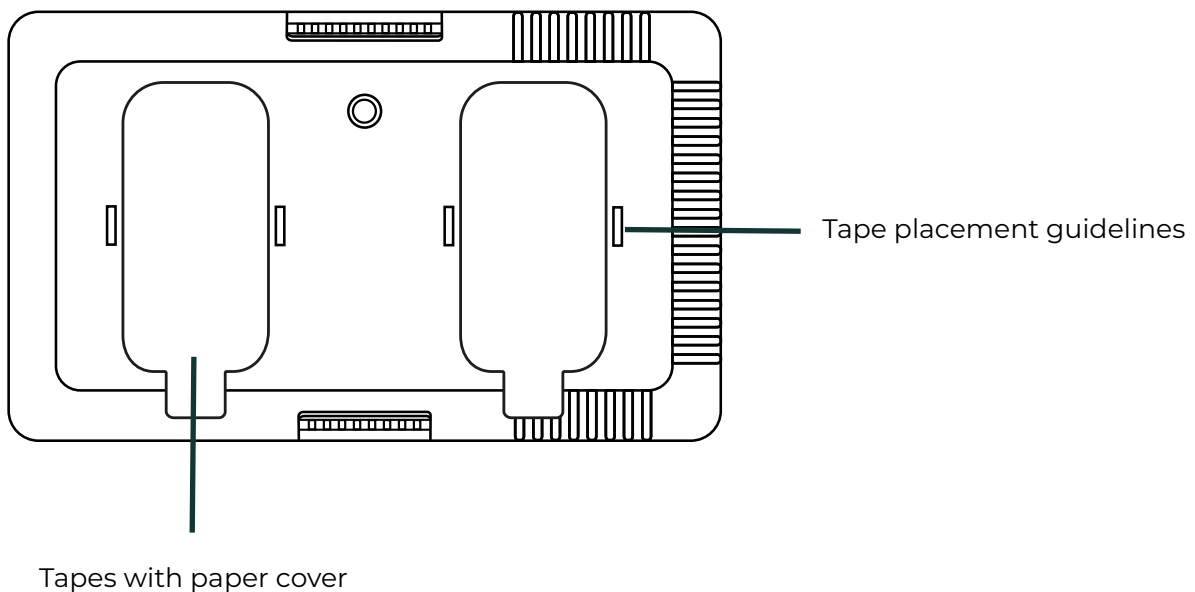

Attach the sensor to its place by pushing it firmly against the surface for a minimum of 5 seconds.

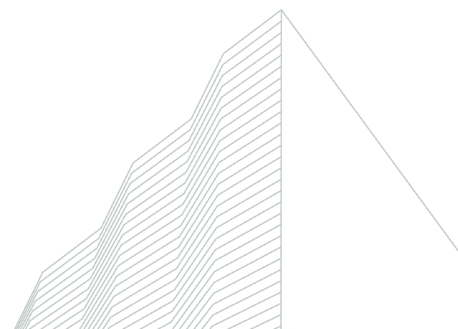

# Installation method 2

## Installing Thingsee AIR with a screw

Take the B-cover and place it on the wall on the decided location. Screw the B-cover to the wall (use anchor with concrete wall or gypsum board).

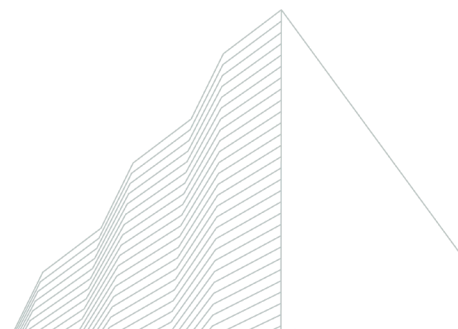
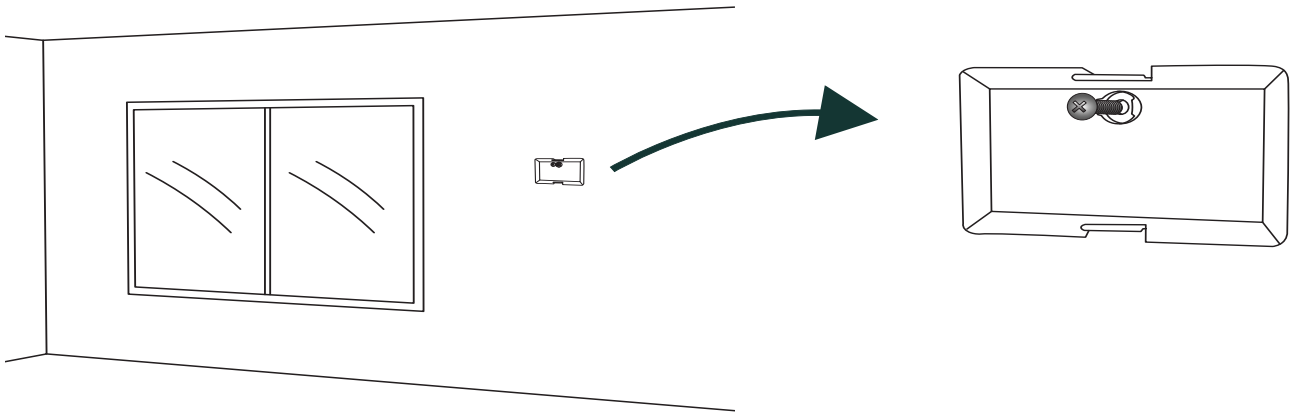

# Detection capability

- CO<sub>2</sub> measurement range 400 – 5 000 ppm. Accuracy  $\pm 30$  ppm, 3% of reading.
- TVOC measurement range 0 – 18000 ppb.
- Operation temperature +5 °C to +50 °C. Accuracy  $\pm 0,2$  °C.
- Relative humidity can be measured between 0 -100 % RH but not recommended to use over 85% humidity. Accuracy  $\pm 2$  %.
- Barometric pressure can be measured between 300 - 1200 hPa. Pressure sensor precision is  $\pm 0.002$  hPa.

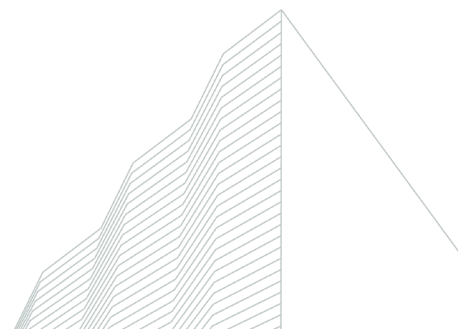
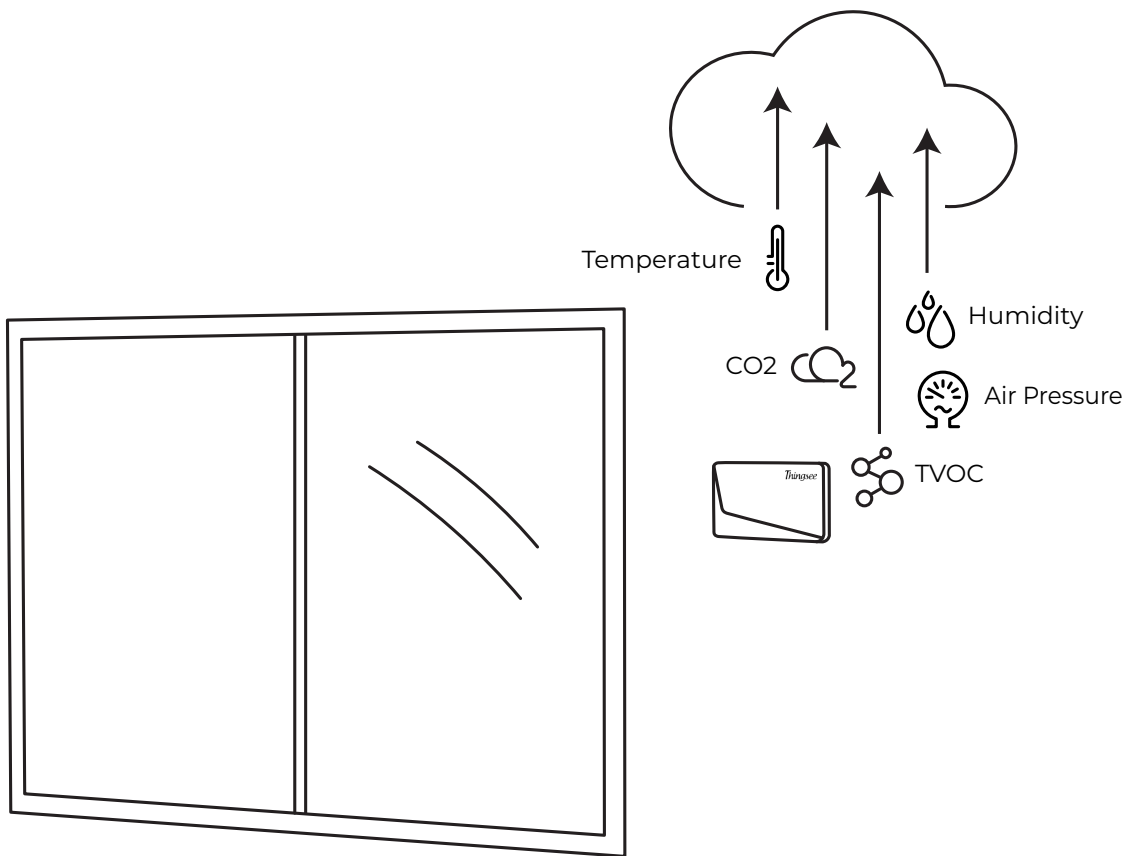

# Examples of reference values

## CO<sub>2</sub> values reference

Level	Possible effects
410-420 ppm	Normal background concentration in outdoor ambient air
420-1000 ppm	Concentrations typical of occupied indoor spaces with good air exchange
1000-2000 ppm	Complaints of drowsiness and poor air
2000-5000 ppm	Headaches, sleepiness and stagnant, stale, stuffy air. Poor concentration, loss of attention, increased heart rate and slight nausea may also be present
> 5000 ppm	Workplace exposure limit (as 8-hour TWA) in most jurisdictions

## TVOC values reference

Level	Hygienic Rating	Recommendation	Exposure Limit	TVOC (ppb)
1 Excellent	No objections	Target value	no limit	0 - 65
2 Good	No relevant objections	Ventilation - airing recommended	no limit	65 - 220
3 Moderate	Some objections	Intensified ventilation - - airing recommended Search for sources	< 12 months	220 - 660
4 Poor	Major objections	Intensified ventilation - - airing necessary Search for sources	< 1 month	660 - 2200
5 Unhealthy	Situation not acceptable	Use only if unavoidable - - intense ventilation necessary	Hours	2200 - 5500



# Default measurement and reporting

## Event based reporting

Reports new values every 5 minutes if there are changes

- CO<sub>2</sub> default threshold value 10 ppm
- TVOC default threshold value 30 ppb
- Temperature when absolute change is 0,5 °C
- Humidity when absolute change is 2 % RH
- Barometric pressure when absolute change is 20 hPa

## Time based reporting

Reports all measurement values every 1 hour

- In case there is a change to the previous measurement, the measured value will be reported.
- In case the measurement value remains at the same level, it's reported every 1 hour.
- Battery reporting interval 6 hours

# Other default settings

- Battery reporting interval 6 hours

## Changing the default settings

The following parameters are configurable remotely over Thingsee Operations Cloud

- Measurement interval
- Reporting interval

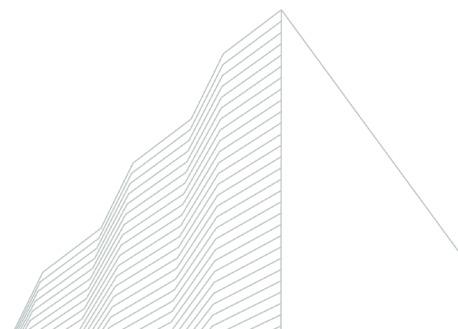



# Device info

Operating temperature +5 °C ... +50° C

Operating humidity 0 % ... 85 % RH non-condensing

Storage temperature +5 °C ... +25 °C

Storage humidity 45% ... 85 % RH non-condensing

IP rating grade: IP30

Certifications: CE, FCC, ISED, RoHS, RCM, MIC, UKCA, WPC ETA-SD, KC and NOM + NYCE, IFT compliant

Battery type: 2 x AA, replaceable

Expected battery life:

- Up to 4 years with 5 minute interval

Radio sensitivity: -95 dBm (BTLE)

More device info can be found at [support.haltian.com](https://support.haltian.com)

# Device dimensions

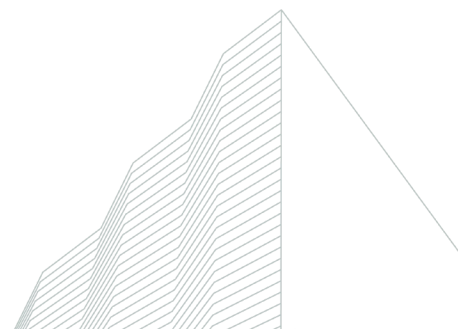
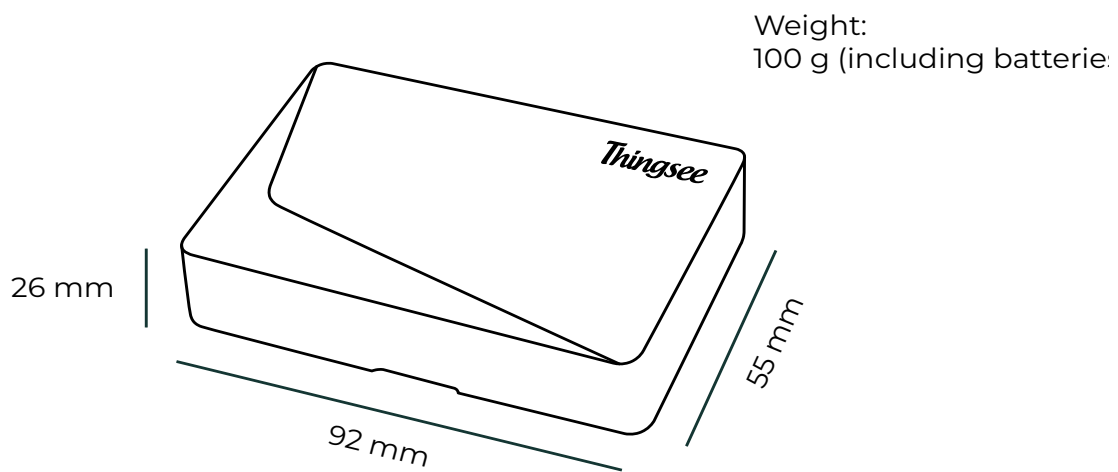

CERTIFICATION INFORMATION  
EU DECLARATION OF CONFORMITY

Hereby, Haltian Oy declares that the radio equipment Thingsee AIR is in compliance with Directive 2014/53/EU. The full text of the EU declaration of conformity is available at the following internet address: [support.haltian.com](http://support.haltian.com)

Haltian Oy vakuuttaa, että radiolaitetyyppi Thingsee AIR on direktiivin 2014/53/EU mukainen. EU-vaatimustenmukaisuusvakuutuksen täysimittainen teksti on saatavilla seuraavassa internetosoitteessa: [support.haltian.com](http://support.haltian.com)

Hereby, Haltian Oy declares that the radio equipment type TCO is in compliance with the UK relevant statutory requirements (Radio Equipment Regulations 2017 (SI 2017 No. 1206)). The full text of the declaration of conformity is available at the following internet address: [support.haltian.com](http://support.haltian.com)

Thingsee AIR operates at Bluetooth® 2.4 GHz frequency band. Maximum radio-frequency power transmitted is +4.0 dBm.

Manufacturer name and address:

Haltian Oy  
Yrttipellontie 1 D  
90230 Oulu  
Finland

FCC REQUIREMENTS FOR OPERATION IN THE UNITED STATES

FCC Information for the User

This product does not contain any user serviceable components and is to be used with approved, internal antennas only. Any product changes or modifications will invalidate all applicable regulatory certifications and approvals.

FCC Guidelines for human Exposure

This equipment complies with FCC radiation exposure limits set forth for an uncontrolled environment. This equipment should be installed and operated with minimum distance of 20 cm between the radiator and your body. This transmitter must not be co-located or operating in conjunction with any other antenna or transmitter.

FCC Radio Frequency Interference Warnings & Instructions

This equipment has been tested and found to comply with the limits for a Class B digital device, pursuant to Part 15 of the FCC Rules. These limits are designed to provide reasonable protection against harmful interference in a residential installation. This equipment uses and can radiate radio frequency energy and, if not installed and used in accordance with the instructions, may cause harmful interference to radio communications. However, there is no guarantee that interference will not occur in a particular installation. If this equipment does cause harmful interference to radio or television reception, which can be determined by turning the equipment off and on, the user is encouraged to try to correct the interference by one or more of the following methods:

Increase the separation between the equipment and the receiver.

Connect the equipment into an electrical outlet on a circuit different from that which the radio receiver is connected.

Consult the dealer or an experienced radio/TV technician for help.

Any changes or modifications not expressly approved by the party responsible for compliance could void the user's authority to operate this equipment.

FCC compliance statement:

This device complies with Part 15 of the FCC Rules. Operation is subject to the following two conditions: (1) this device may not cause harmful interference, and (2) this device must accept any interference received, including interference that may cause undesired operation.

Innovation, Science and Economic Development Canada (ISED) regulatory information

This device complies with RSS-247 of the Innovation, Science and Economic Development Canada (ISED) Rules. Operation is subject to the following two conditions: (1) This device may not cause harmful interference, and (2) this device must accept any interference received, including interference that may cause undesired operation.

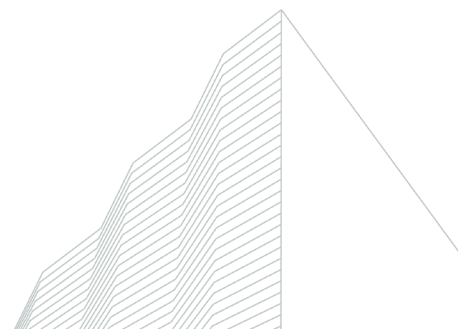

Ce dispositif est conforme à la norme CNR-247 d'Innovation, Sciences et Développement économique Canada applicable aux appareils radio exempts de licence. Son fonctionnement est sujet aux deux conditions suivantes: (1) le dispositif ne doit pas produire de brouillage préjudiciable, et (2) ce dispositif doit accepter tout brouillage reçu, y compris un brouillage susceptible de provoquer un fonctionnement indésirable

Radiation Exposure Statement :

This device complies with ISED radiation exposure limits set forth for an uncontrolled environment. This equipment must be installed and used with a minimum distance of 20 cm between the radiator and your body.

NOTE IMPORTANTE: Déclaration d'exposition aux radiations:

Cet équipement est conforme aux limites d'exposition aux rayonnements ISED établies pour un environnement non contrôlé. Cet équipement doit être installé et utilisé avec une distance minimale de 20 cm entre le radiateur et votre corps.

FCC ID: 2AEU3TSAIR

IC: 20236-TSAIR

RCM-approved for Australia, New Zealand, Japan and India.

Modelo: ANATEL: 04469-24-16620

Para maiores informações, consulte o site da ANATEL [www.gov.br/anatel/pt-br](http://www.gov.br/anatel/pt-br)

Este equipamento não tem direito à proteção contra interferência prejudicial e não pode causar interferência em sistemas devidamente autorizados. Este produto não é apropriado para uso em ambientes domésticos, pois poderá causar interferências eletromagnéticas que obrigam o usuário a tomar medidas necessárias para minimizar estas interferências.

La operación de este equipo está sujeta a las siguientes dos condiciones: (1) es posible que este equipo o dispositivo no cause interferencia perjudicial y (2) este equipo o dispositivo debe aceptar cualquier interferencia, incluyendo la que pueda causar su operación no deseada.

No se recomienda el uso de este producto a una distancia menor a 20cm del cuerpo humano.

SAFETY GUIDE

Read these simple guidelines. Not following them may be dangerous or against local laws and regulations. For further information, read the user guide and visit [www.haltian.com](http://www.haltian.com)

Usage

Do not cover the device as it prevents the device from operating properly.

- This product is intended for indoor use only and shall not be exposed to rain.
- Do not modify the device. Unauthorized modifications may damage the device and violate regulations governing radio devices.
- Do not store the device in wet or humid conditions.
- Remove the batteries from the device if you are taking it inside an aeroplane. The device has a Bluetooth LE receiver/transmitter which must not be operational during a flight.
- Please take care that the used batteries are recycled by taking them to an appropriate collection point.
- When changing batteries, replace both of them at the same time using identical brand and type.
- Do not swallow batteries.
- Do not throw batteries into water or fire.
- Do not short-circuit batteries.
- Do not try to charge primary batteries.
- Do not open or disassemble batteries.
- Batteries should be stored in a dry place and at room temperature. Avoid large temperature changes and direct sunlight.

At higher temperature the electrical performance of the batteries may be reduced.

- Keep batteries away from children.

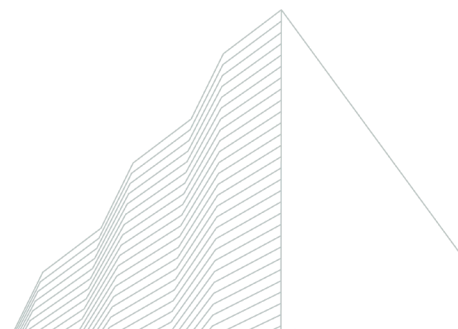

### Care and maintenance

Handle your device with care. The following suggestions help you keep your device operational.

- Do not open the device other than as instructed in the user guide.
- Unauthorized modifications may damage the device and violate regulations governing radio devices.
- Do not drop, knock, or shake the device. Rough handling can break it.
- Only use a soft, clean, dry cloth to clean the surface of the device. Do not clean the device with solvents, toxic chemicals or strong detergents as they may damage your device and void the warranty.
- Do not paint the device. Paint can prevent proper operation.

### Damage

If the device is damaged contact [support@haltian.com](mailto:support@haltian.com). Only qualified personnel may repair this device.

### Small children

Your device is not a toy. It may contain small parts. Keep them out of the reach of small children.

### RECYCLING

Check the local regulations for proper disposal of electronic products. The Directive on Waste Electrical and Electronic Equipment (WEEE), which entered into force as European law on 13th February 2003, resulted in a major change in the treatment of electrical equipment at end-of-life. The purpose of this Directive is, as a first priority, the prevention of WEEE, and in addition, to promote the reuse, recycling and other forms of recovery of such wastes so as to reduce disposal.

The crossed-out wheelie-bin symbol on your product, battery, literature, or packaging reminds you that all electrical and electronic products and batteries must be taken to separate collection at the end of their working life. Do not dispose of these products as unsorted municipal waste: take them for recycling. For info on your nearest recycling point, check with your local waste authority.

	1. Equipment name, Model name: Thingsee AIR, TCO
	2. Registration No: R-R-2ae-TCO
	3. Applicant name: Haltian Oy
	4. Manufacture date: 2024
	5. Manufacturer / Country of Origin: Haltian Oy / Finland

<b>Sensor de Aire (Thingsee AIR)</b>
<b>Marca:</b> Thingsee
<b>Modelo:</b> TCO
<b>Fabricante:</b> Haltian Oy
2 pilas alcalinas AA
Hecho en Finlandia
<b>Certification number:</b> CETHTC24-27684



Innovation, Science and  
Economic Development Canada

Innovation, Sciences et  
Développement économique Canada

RoHS



# Get to know all our Haltian devices



Thingsee  
PRESENCE



Thingsee  
ENVIRONMENT



Thingsee ENVIRONMENT  
RUGGED



Thingsee LEAKAGE  
RUGGED

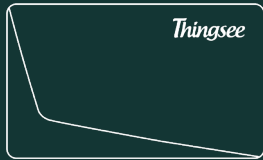

Thingsee  
AIR



Thingsee  
BEAM

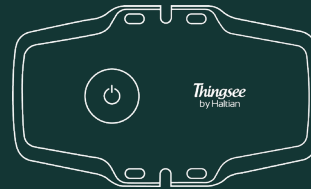

Thingsee GATEWAY  
GLOBAL



Haltian  
RADAR

For all devices and more information, visit our website  
[www.haltian.com](http://www.haltian.com) or contact [sales@haltian.com](mailto:sales@haltian.com)

